

**GTV**

**GTV**

# Furniture Accessories

**PRIBOR ZA  
NAMJEŠTAJ**



**dugatehna**

# GTV



**BAGLAME**

**dugatehna**

Šifra  
91089/1

Naziv  
GTV RAVNA 09 BAGLAMA, H=0, BEZ EURO VIJKA

GTV kod  
ZP-BICN090BE-V6

## BICN

Ravna klasična baglama + podloška H=0

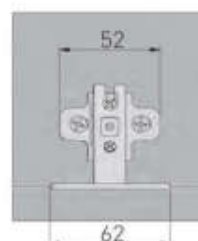
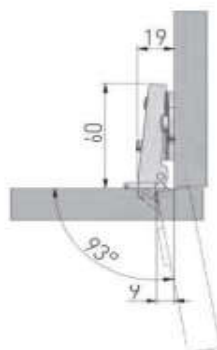

ZP-BICN090BE	H = 0	—	nikel, nickel	stal, steel
--------------	-------	---	------------------	----------------

Šifra  
91152/1

Naziv  
GTV PRESTIGE 09 RAVNA BAGLAMA, SLOW/CLIP-ON/H=0, SINGLE PACK

GTV kod  
ZM-ECHC09BEO

92724 (VERZIJA BAGLAME U REFUZNOM PAKIRANJU)

## ECHC



PRESTIGE hidraulična ravna baglama, 3D podloška, tiho zatvaranje, clip on, pokrivne kapice, single pack

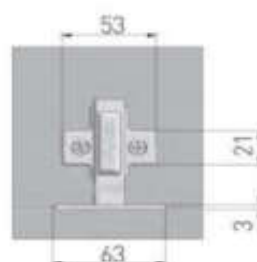
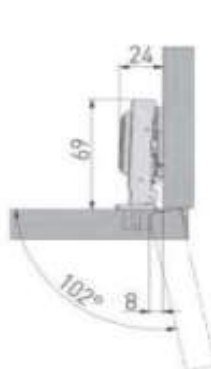

ZM-ECHC09BEO	H = 0	x 4	—	nikel, nickel, stainless steel, nickel	stal, steel, crank, acel
--------------	-------	-----	---	--	-----------------------------------

**Šifra** 91152/POLU **Naziv** GTV PRESTIGE 08 POLUKOLJENO BAGLAMA, SLOW/CLIP-ON/H=0, SINGLE PA

**GTV kod** ZM-ECHC08BEO

## ECHC

PRESTIGE hidraulična baglama polukoljeno, 3D podloška, tiho zatvaranje, clip on, pokrivne kapice, single pack

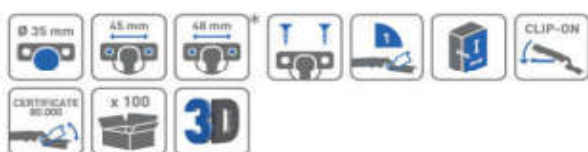
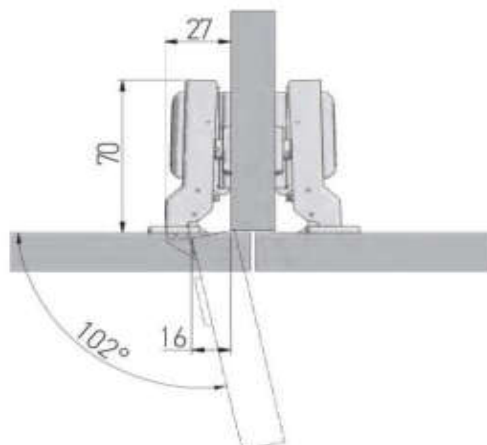

ZM-ECHC08BEO	H = 0	x 4	—	nikel, nickel, нікель, nikkel	stal, steel, сталь, acél
--------------	-------	-----	---	--	-----------------------------------

**Šifra** 91152/PUNO **Naziv** GTV PRESTIGE 07 PUNOKOLJENO BAGLAMA, SLOW/CLIP-ON/H=0, SINGLE PA

**GTV kod** ZM-ECHC07BEO

## ECHC

PRESTIGE hidraulična baglama punokoljeno, 3D podloška, tiho zatvaranje, clip on, pokrivne kapice, single pack

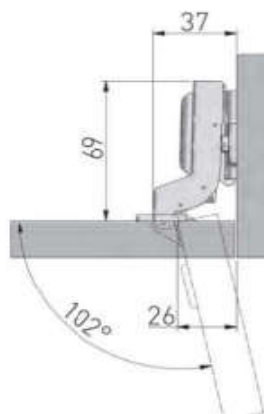

ZM-ECHC07BEO	H = 0	x 4	—	nikel, nickel, нікель, nikkel	stal, steel, сталь, acél
--------------	-------	-----	---	--	-----------------------------------

**Šifra** 92721/RAVNA  
**Naziv** GTV SOLID PLUS 09 RAVNA BAGLAMA, 3D/SLOW/CLIP-ON/H=0  
 92842 (VERZIJA BAGLAME SA EURO VIJKOM)  
 92788/RAVNA (VERZIJA BAGLAME BEZ TIHOG ZATVARANJA)

**GTV kod**  
 ZM-DCHC09-3DBEO

## SOLID PLUS

Hidraulična ravna baglama,  
 3D podloška, ekcentrično podešavanje,  
 tiho zatvaranje, clip on

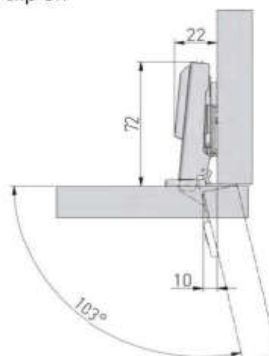

ZM-DCHC09-3DBEO	H = 0	—	—	nikel, nikkel, nikkel	stal, steel, сталь, acél
ZM-DCHC09-3DZEO		—	x 2		

**Šifra** 92721/POLU  
**Naziv** GTV SOLID PLUS 08 POLUKRIVA BAGLAMA, 3D/SLOW/CLIP-ON/H=0

**GTV kod**  
 ZM-DCHC08-3DBEO

## SOLID PLUS

Hidraulična baglama polukoljeno,  
 3D podloška, tiho zatvaranje, clip on

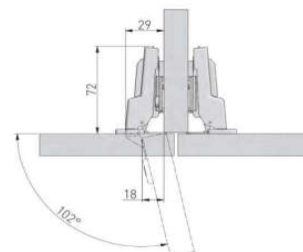

ŠIFRA: 92721/POLU



ZM-DCHC08-3DBEO	H = 0	—	—	nikel, nikkel, nikkel	stal, steel, сталь, acél
-----------------	-------	---	---	-----------------------------	-----------------------------------

**Šifra** 92721/KRIVA  
**Naziv** GTV SOLID PLUS 07 KRIVA BAGLAMA, 3D/SLOW/CLIP-ON/H=0

**GTV kod**  
 ZM-DCHC07-3DBEO

## SOLID PLUS

Hidraulična baglama punokoljeno,  
 3D podloška, tiho zatvaranje, clip on

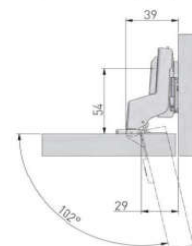

ZM-DCHC07-3DBEO	H = 0	—	—	nikel, nikkel, nikkel	stal, steel, сталь, acél
-----------------	-------	---	---	-----------------------------	-----------------------------------

Šifra 92787/RAV Naziv GTV PRO CRNA RAVNA BAGLAMA, 3D(SKRIVENI)/SLOW/CLIP-ON, SINGLE PA GTV kod ZM-DCHCB09-3DBEO-20 Boja Antracit

BAGLAMA SA SKRIVENOM 3D PODLOŠKOM



Šifra 92915 Naziv BAGLAMA RAVNA SILENTO PRO SLOW/CLIP ON GTV kod ZM-HCSL09-3D

## SILENTO PRO

Hidraulična ravna baglama, tiho zatvaranje, preklapanje, ekscentrično podesiva dubinom

3D podloška za Silent pro baglamu

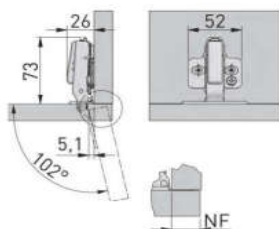

ŠIFRA: 92919  
PZ-HCSL3D-H0-BEO

Klasična podloška za Silent pro baglamu



Šifra	Dimenzije	Boja	Materiali
ZM-HCSL09-3D			
ZM-HCSL09-3DBEO	H = 0	—	nikiel, nikel, nikel, nikel
ZM-HCSL09-3DBEO-20			czarna, black, чорний, fekete



ŠIFRA: 92918  
PZ-HCSL-H0-BEO

Šifra 91017 Naziv GTV INNOVO 09 RAVNA BAGLAMA, SLOW/CLIP-ON/H=0, BEZ 3D PODLOŠKE GTV kod ZM-INHC090BEO

## INHC

INNOVO hidraulična ravna baglama, tiho zatvaranje, clip on, bez 3D podloške

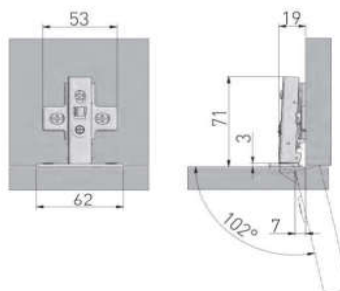

Šifra	Dimenzije	Boja	Materiali
ZM-INHC090BEO	H = 0	—	nikiel, nikel, nikel, nikel

Šifra 92795 Naziv BAGLAMA RAVNA BEZ OPRUGE 110\* BEZ EURO VIJKA H=0 S REGULACIJOM GTV kod ZP-COCA450-BE

## COCA

Ravna baglama bez opruge, 110°, sa podloškom H=0



Šifra 91214/1 Naziv GTV BAGLAMA 07 KRIVA/PUNO KOLJENO, H=0 BEZ EURO VIJKA GTV kod ZP-BICN070BE



Šifra 91226/1 Naziv GTV BAGLAMA 08 POLUKRIVA/POLUKOLJENO, H=0 BEZ EURO VIJKA GTV kod ZP-BICN080BE



Šifra  
92722/90

Naziv  
GTV HCKT 90° BAGLAMA, SLOW/CLIP-ON/H=0/BEZ EURO,  
SINGLE PACK

GTV kod  
ZM-HCKT90-BE-S

## HCKT

Baglama 90° (paralelna), tiho zatvaranje, clip on, **bez** 3D podloške, single pack

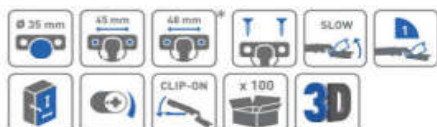
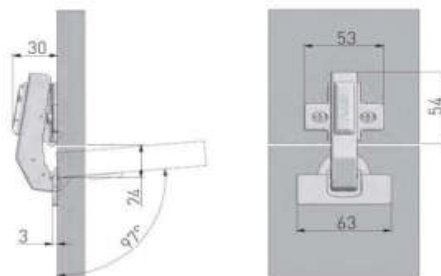

ZM-HCKT90-BE-S	H = 0	x 4	—	nikiel, nickel, нікель, nikkel	stal, steel, сталь, acel
----------------	-------	-----	---	---	-----------------------------------

Šifra  
92722/165

Naziv  
GTV HCKT 165° BAGLAMA, SLOW/CLIP-ON/H=0/BEZ EURO,  
SINGLE PACK

GTV kod  
ZM-HCKT165BE-S

## HCKT

Baglama 165°, tiho zatvaranje, clip on, **bez** 3D podloške, single pack

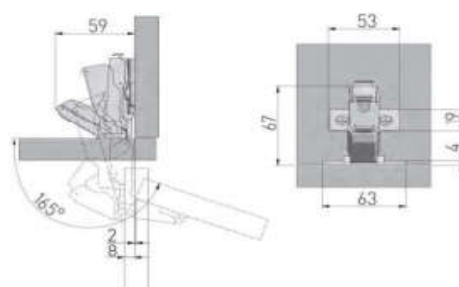
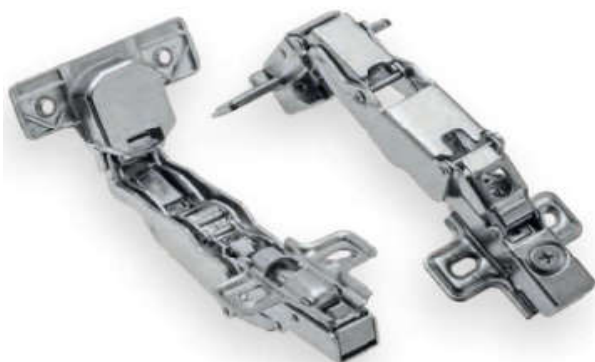

ZM-HCKT165BE-S	H = 0	—	—	nikiel, nickel, нікель, nikkel	stal, steel, сталь, acel
----------------	-------	---	---	---	-----------------------------------

Šifra  
92881/45

Naziv  
GTV PRESTIGE BAGLAMA 45°, 3D/SLOW/CLIP-ON/H=0, SINGLE  
PACK

GTV kod  
ZM-HCKT45-3DBEO-S

## HCKT



PRESTIGE baglama 45°, 3D podloška, tiho zatvaranje,  
clip on, single pack

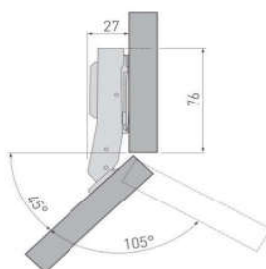

ZM-HCKT45-3DBEO-S	H = 0	x 4	—	nikiel, nikkel, nikkel	stal, steel, acciaio, acél
-------------------	-------	-----	---	------------------------------	-------------------------------------

Šifra  
92881/90

Naziv  
GTV PRESTIGE BAGLAMA 90°, 3D/SLOW/CLIP-ON/H=0, SINGLE  
PACK

GTV kod  
ZM-HCKT90-3DBEO-S

## HCKT



PRESTIGE baglama 90° (paralelna), 3D podloška,  
tiho zatvaranje, clip on, single pack

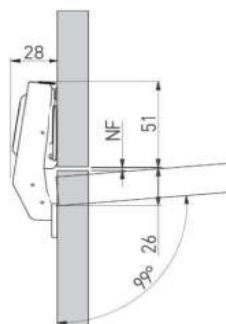

ZM-HCKT90-3DBEO-S	H = 0	x 4	—	nikiel, nikkel, nikkel	stal, steel, acciaio, acél
-------------------	-------	-----	---	------------------------------	-------------------------------------

Šifra  
92881/165

Naziv  
GTV PRESTIGE BAGLAMA 165°, 3D/SLOW/CLIP-ON/H=0,  
SINGLE PACK

GTV kod  
ZM-HCKT165-3DBEO-S

## HCKT



PRESTIGE baglama 165°, 3D podloška,  
tiho zatvaranje, clip on, single pack

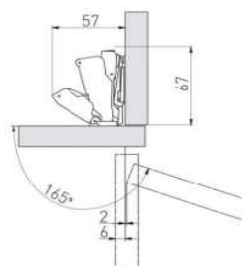

ZM-HCKT165-3DBEO-S	H = 0	—	—	nikiel, nikkel, nikkel	stal, steel, acciaio, acél
--------------------	-------	---	---	------------------------------	-------------------------------------

# GTV



**VODILICE**

**dugatehna**

## KUGLIČNA VODILICA ECONOMIC H45

DULJINE U IZVEDBI: 250, 300, 350, 400, 500, 550, 600 i 700 mm

ŠIFRA: 91170/...

KATALOŠKI BROJ: PK-0H45...XP

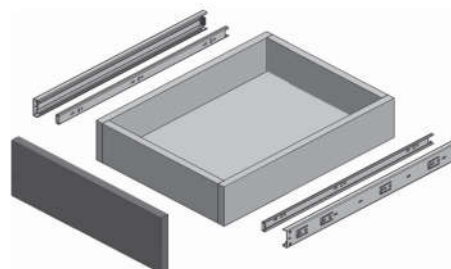

## KUGLIČNA VODILICA PRESTIGE H45

DULJINE U IZVEDBI: 250, 300, 350, 400, 500, 550, 600 i 700 mm

ŠIFRA: 91175/...

KATALOŠKI BROJ: PK-0-H45-...

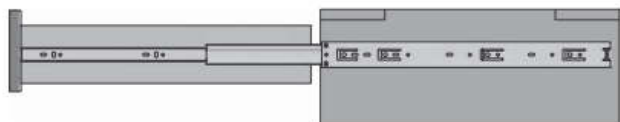

## KUGLIČNA VODILICA VERSALITE H45, SA MEHANIZMOM ZA TIHO ZATVARANJE

DULJINE U IZVEDBI: 250, 300, 350, 400, 500, 550, 600 mm

ŠIFRA: 91172/...

KATALOŠKI BROJ: PK-L-H45-...-A

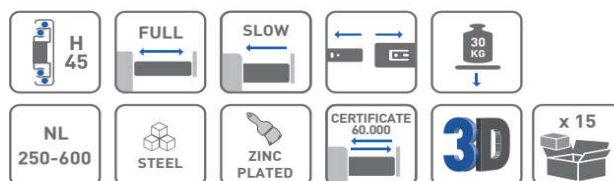

## KUGLIČNA VODILICA PRESTIGE H45, SA MEHANIZMOM ZA OTVARANJE NA DODIR

DULJINE U IZVEDBI: 250, 300, 350, 400, 500, 550, 600 mm

ŠIFRA: 91216/...

KATALOŠKI BROJ: PK-P-H45-...-GX



## KUGLIČNA VODILICA SA MEHANIZMOM NOSIVOSTI DO 100 kg, H53

DULJINE U IZVEDBI:

300, 350, 400, 500, 550, 600, 700, 750, 800, 850, 900, 950, 1000, 1050, 1100, 1200 mm

ŠIFRA: 92591/...

KATALOŠKI BROJ: PK-0-H53-....



## ČELIČNA VODILICA LADICE CLASSIC, BIJELA

DULJINE U IZVEDBI: 250, 300, 350, 400, 500, 550, 600 mm

ŠIFRA: 91174/...

KATALOŠKI BROJ: PR-0B-...-10



## ČELIČNA VODILICA LADICE PRESTIGE, BIJELA

DULJINE U IZVEDBI: 250, 300, 350, 400, 500, 550, 600 mm

ŠIFRA: 92901/...

KATALOŠKI BROJ: PR-SP-...-10



## MODERN SLIDE 3D, KUGLIČNA SKRIVENA VODILICA S USPORIVAČEM ZATVARANJA, NEPOTPUNA IZVLAKA, ZA DEBLJINU PLOČE 18mm

DULJINE U IZVEDBI: 300, 350, 400, 500, 550 mm

ŠIFRA: 92580/...

KATALOŠKI BROJ: PB-GCHX18-...-H

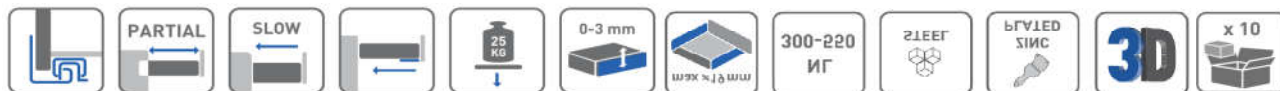

## MODERN SLIDE 3D, KUGLIČNA SKRIVENA VODILICA S USPORIVAČEM ZATVARANJA, POTPUNA IZVLAKA, ZA DEBLJINU PLOČE 18mm

DULJINE U IZVEDBI: 300, 350, 400, 500, 550 mm

ŠIFRA: 92587/...

KATALOŠKI BROJ: PB-3DOSH18-...-H

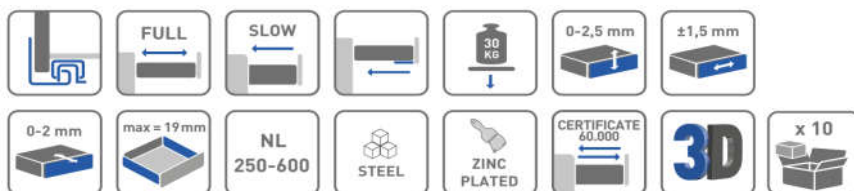

**GTV**



**MODERN  
BOX  
SQUARE**

**dugatehna**

## MODERN BOX SQUARE



Nosivost 40 kg

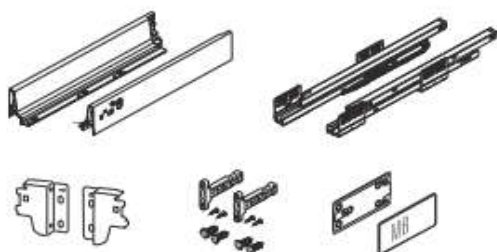

Folder	Height	Color
PB-KW-KPL350A1	350	white
PB-KW-KPL400A1	400	
PB-KW-KPL450A1	450	
PB-KW-KPL500A1	500	gray,
PB-KW-KPL350A	350	
PB-KW-KPL400A	400	
PB-KW-KPL450A	450	
PB-KW-KPL500A	500	

ŠIFRA: 92868/...

## MODERN BOX SQUARE

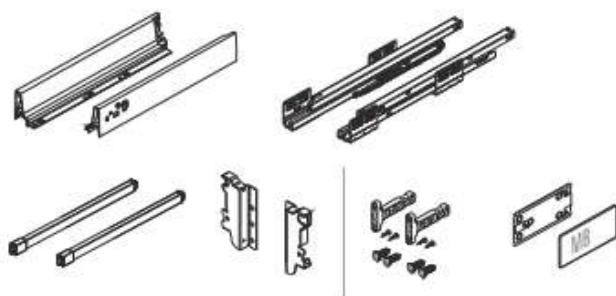

Folder	Height	Color
PB-KW-KPL350B1	350	white
PB-KW-KPL400B1	400	
PB-KW-KPL450B1	450	
PB-KW-KPL500B1	500	gray
PB-KW-KPL350B	350	
PB-KW-KPL400B	400	
PB-KW-KPL450B	450	
PB-KW-KPL500B	500	

ŠIFRA: 92867/...

## MODERN BOX SQUARE

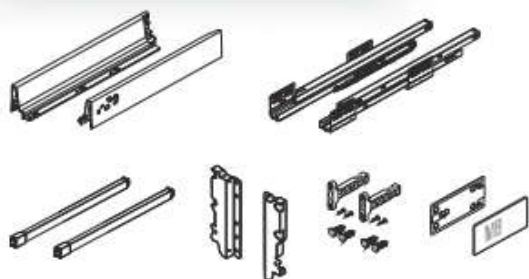

	Šifra	Boja
PB-KW-KPL350C1	350	white
PB-KW-KPL400C1	400	
PB-KW-KPL450C1	450	
PB-KW-KPL500C1	500	
PB-KW-KPL350C	350	gray
PB-KW-KPL400C	400	
PB-KW-KPL450C	450	
PB-KW-KPL500C	500	

ŠIFRA: 92868/...

### RELING ZA MODERN BOX, 500mm

ŠIFRA: 91062/R500

KATALOŠKI BROJ: PB-D-REL5000



**GTV**

**AXIS  
PRO**

**dugatehna**



weight capacity



silent closing



3D Adjustment



Full Access

## AXIS PRO

soft close

### H86



## AXIS PRO

soft close

### H200



## AXIS PRO

soft close with glass sides

### H168



## AXIS PRO

soft close with glass sides

### H168



## AXIS PRO

soft close with glass sides

### H86



## AXIS PRO

soft close

### H168



## AXIS PRO

push to open

### H69



## AXIS PRO

soft close

### H120



## AXIS PRO

push to open

### H168



## AXIS PRO

soft close

# H86



ŠIFRE:  
92845/...  
92860/...  
92951/...

	L	
PB-AXISPRO-KPL250A1	250	white
PB-AXISPRO-KPL300A1	300	
PB-AXISPRO-KPL350A1	350	
PB-AXISPRO-KPL400A1	400	
PB-AXISPRO-KPL450A1	450	
PB-AXISPRO-KPL500A1	500	
PB-AXISPRO-KPL550A1	550	
PB-AXISPRO-KPL600A1	600	
PB-AXISPRO-KPL250A	250	anthracite
PB-AXISPRO-KPL300A	300	
PB-AXISPRO-KPL350A	350	
PB-AXISPRO-KPL400A	400	
PB-AXISPRO-KPL450A	450	
PB-AXISPRO-KPL500A	500	
PB-AXISPRO-KPL550A	550	
PB-AXISPRO-KPL600A	600	

## AXIS PRO

soft close

# H120

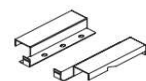
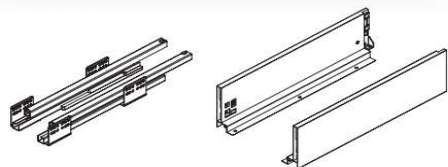

× 4  
A

× 18  
B



ŠIFRA: 92848/...

	L mm	
PB-AXISPRO-KPL250B1	250	white
PB-AXISPRO-KPL300B1	300	
PB-AXISPRO-KPL350B1	350	
PB-AXISPRO-KPL400B1	400	
PB-AXISPRO-KPL450B1	450	
PB-AXISPRO-KPL500B1	500	
PB-AXISPRO-KPL550B1	550	
PB-AXISPRO-KPL600B1	600	
PB-AXISPRO-KPL250B	250	anthracite
PB-AXISPRO-KPL300B	300	
PB-AXISPRO-KPL350B	350	
PB-AXISPRO-KPL400B	400	
PB-AXISPRO-KPL450B	450	
PB-AXISPRO-KPL500B	500	
PB-AXISPRO-KPL550B	550	
PB-AXISPRO-KPL600B	600	

## AXIS PRO

soft close

# H168

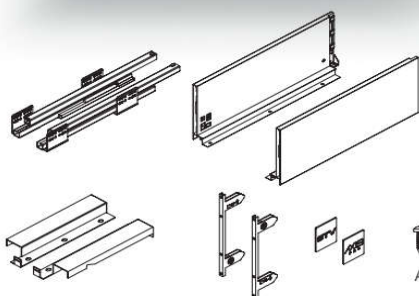

A x 8  
B x 18

ŠIFRE:  
92846/...  
92861/...  
92952/...

	L mm	
PB-AXISPRO-KPL250C1	250	white
PB-AXISPRO-KPL300C1	300	
PB-AXISPRO-KPL350C1	350	
PB-AXISPRO-KPL400C1	400	
PB-AXISPRO-KPL450C1	450	
PB-AXISPRO-KPL500C1	500	
PB-AXISPRO-KPL550C1	550	
PB-AXISPRO-KPL600C1	600	
PB-AXISPRO-KPL250C	250	anthracite
PB-AXISPRO-KPL300C	300	
PB-AXISPRO-KPL350C	350	
PB-AXISPRO-KPL400C	400	
PB-AXISPRO-KPL450C	450	
PB-AXISPRO-KPL500C	500	
PB-AXISPRO-KPL550C	550	
PB-AXISPRO-KPL600C	600	

## AXIS PRO

soft close

# H200

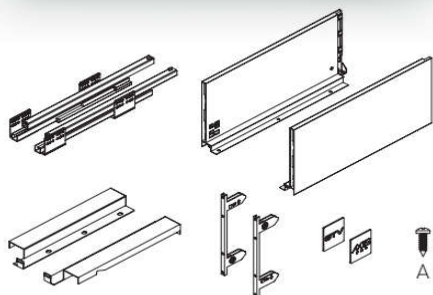

A x 8  
B x 18

ŠIFRE:  
92847/...  
92862/...  
92953/...

	L mm	
PB-AXISPRO-KPL250D1	250	white
PB-AXISPRO-KPL300D1	300	
PB-AXISPRO-KPL350D1	350	
PB-AXISPRO-KPL400D1	400	
PB-AXISPRO-KPL450D1	450	
PB-AXISPRO-KPL500D1	500	
PB-AXISPRO-KPL550D1	550	
PB-AXISPRO-KPL600D1	600	
PB-AXISPRO-KPL250D	250	anthracite
PB-AXISPRO-KPL300D	300	
PB-AXISPRO-KPL350D	350	
PB-AXISPRO-KPL400D	400	
PB-AXISPRO-KPL450D	450	
PB-AXISPRO-KPL500D	500	
PB-AXISPRO-KPL550D	550	
PB-AXISPRO-KPL600D	600	



## AXIS PRO - OTVARANJE NA DODIR

# AXIS PRO

push to open

92863/300	AXIS PRO PTO 300 BIJELI H=84 A-NISKI	PB-AXISPRO-P2O-KPL30( Bijela
92863/350	AXIS PRO PTO 350 BIJELI H=84 A-NISKI	PB-AXISPRO-P2O-KPL35( Bijela
92863/400	AXIS PRO PTO 400 BIJELI H=84 A-NISKI	PB-AXISPRO-P2O-KPL40( Bijela
92863/450	AXIS PRO PTO 450 BIJELI H=84 A-NISKI	PB-AXISPRO-P2O-KPL45( Bijela
92863/500	AXIS PRO PTO 500 BIJELI H=84 A-NISKI	PB-AXISPRO-P2O-KPL50( Bijela
92864/350	AXIS PRO PTO 350 BIJELI H=167 C-VISOKI	PB-AXISPRO-P2O-KPL35( Bijela
92864/400	AXIS PRO PTO 400 BIJELI H=167 C-VISOKI	PB-AXISPRO-P2O-KPL40( Bijela
92864/450	AXIS PRO PTO 450 BIJELI H=167 C-VISOKI	PB-AXISPRO-P2O-KPL45( Bijela
92864/500	AXIS PRO PTO 500 BIJELI H=167 C-VISOKI	PB-AXISPRO-P2O-KPL50( Bijela
92865/300	AXIS PRO PTO 300 BIJELI H=199 D-VRLO VISOKI	PB-AXISPRO-P2O-KPL30( Bijela
92865/350	AXIS PRO PTO 350 BIJELI H=199 D-VRLO VISOKI	PB-AXISPRO-P2O-KPL35( Bijela
92865/400	AXIS PRO PTO 400 BIJELI H=199 D-VRLO VISOKI	PB-AXISPRO-P2O-KPL40( Bijela
92865/450	AXIS PRO PTO 450 BIJELI H=199 D-VRLO VISOKI	PB-AXISPRO-P2O-KPL45( Bijela
92865/500	AXIS PRO PTO 500 BIJELI H=199 D-VRLO VISOKI	PB-AXISPRO-P2O-KPL50( Bijela

### SINKRONIZATOR

92869/SINK      AXIS PRO PTO SINKRONIZATOR 1200 MM      PB-AXISPRO-SYNCHRO-P2O



# GTV

## AXIS PRO SA STAKLENIM STIJENKAMA



# AXIS PRO

soft close with glass sides

92904/500  
92905/500  
92906/500  
92907/500

AXIS PRO GLASS 500 BIJELA H= 84 A-NISKI  
AXIS PRO GLASS 500 BIJELA H=168 C-VISOKI  
AXIS PRO GLASS 500 ANTRACIT H=84 A-NISKI  
AXIS PRO GLASS 500 ANTRACIT H=168 C-VISOKI

PB-AXISPRO-GLASS-KPL5 Bijela  
PB-AXISPRO-GLASS-KPL5 Bijela  
PB-AXISPRO-GLASS-KPL5 Bijela  
PB-AXISPRO-GLASS-KPL5 Bijela

## AXIS SUSTAV LADICA U LADICI

Šifra

92841/N500  
92841/C500  
92841/D500

GTV kod

PB-AXISPRO-ZESWEW-A1  
PB-AXISPRO-ZESWEW-C1  
PB-AXISPRO-ZESWEW-D1



KUTNA SPOJKA

Šifra:

92913/A500  
92913/B500  
92913/C500  
92913/A500

GTV kod

PB-AXISPRO-WEWMOCA1  
PB-AXISPRO-WEWMOCB1  
PB-AXISPRO-WEWMOCC1  
PB-AXISPRO-WEWMOCD1

# dugatehna

## ORGANIZATOR ESCAJGA ZA LADICE



Šifra	Naziv	GTV kod	Boja
92859/400	ORGANIZATOR ESCAJGA 400 (282-340) ANTRACIT	WK-SZ-AS-400-60	Antracit
92859/500	ORGANIZATOR ESCAJGA 500 (382-440) ANTRACIT	WK-SZ-AS-500-60	Antracit
92859/600	ORGANIZATOR ESCAJGA 600 (482-540) ANTRACIT	WK-SZ-AS-600-60	Antracit
92859/800	ORGANIZATOR ESCAJGA 800 (682-740) ANTRACIT	WK-SZ-AS-800-60	Antracit
92859/900	ORGANIZATOR ESCAJGA 900 (782-840) ANTRACIT	WK-SZ-AS-900-60	Antracit

## PROSTIRKA PROTIV KLIZANJA ZA LADICE



Šifra	Naziv	GTV kod	Boja
92764/B	PROSTIRKA PROTIV KLIZANJA ZA LADICE 480mm/5m, BIJELA	MA-MATA-1-10	Bijela
92764/C	PROSTIRKA PROTIV KLIZANJA ZA LADICE 480mm/5m, CRNA	MA-MATA-1-20	Crna

## AMORTIZER ZATVARANJA VRATA, TIP ON

Šifra	Naziv	GTV kod	Boja
92796/DUGI	TIP ON DUGI S MAGNETOM ANTRACIT	AM-SVN-DL-MG-60	Antracit



## PLINSKI PODIZAČ KUHINJSKIH FRONTI

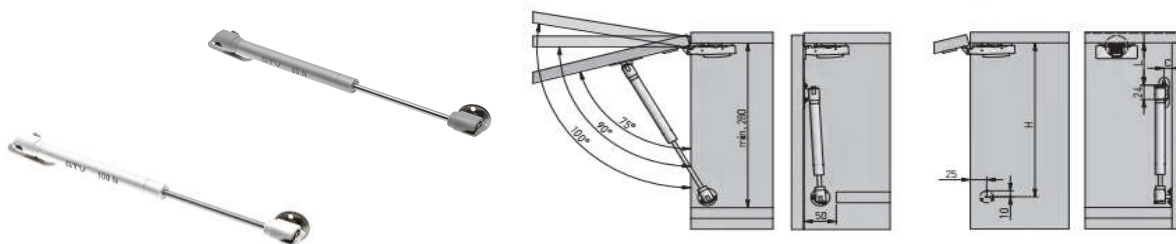

**Šifra**  
91010/... PLINSKI PODIZAC 100N SIVI

**Jačina: 60N, 80N, 100N i 120N**

92602/... PLINSKI PODIZAČ INDUSTRY, BIJELI

**Jačina: 60N, 80N, 100N i 120N**

**GTV kod**  
PD-G0...-N02

**Boja:**  
Siva

PD-G0...-02-N10

**Bijela**

## PLINSKI PODIZAČ FRONTI S USPORIVAČEM

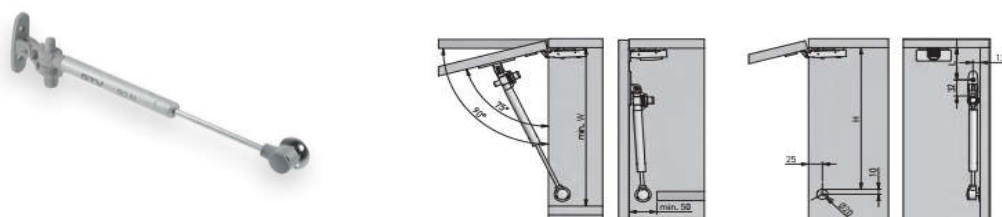

**Šifra**  
92643/60 PLINSKI PODIZAČ S USPORIVAČEM 60N SIVI  
92643/80 PLINSKI PODIZAČ S USPORIVAČEM 80N SIVI  
92643/100 PLINSKI PODIZAČ S USPORIVAČEM 100N SIVI

**GTV kod**  
PD-GAM060-N02  
PD-GAM080-N02  
PD-GAM100-N02

## PLINSKI PODIZAČ ECG ZA BAR (PREMA DOLJE)

**Šifra**  
92573/60 ECG PLINSKI PODIZAČ ZA BAR (PREMA DOLJE) 60N  
92573/80 ECG PLINSKI PODIZAČ ZA BAR (PREMA DOLJE) 80N

**GTV kod**  
PD-ECGDL-060  
PD-ECGDL-080

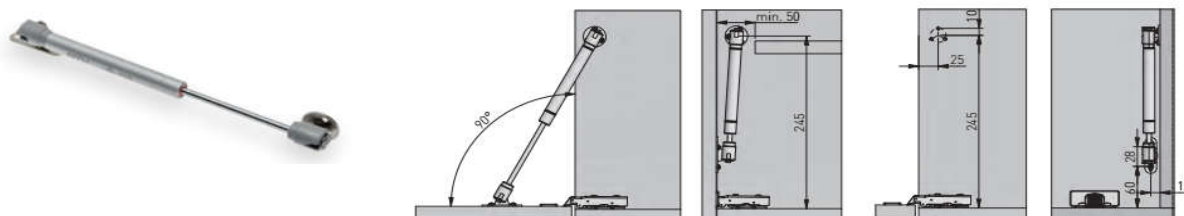

**Šifra**  
92889 DRŽAČ PADAJUĆIH VRATA (BIFE VRATA)

**GTV kod**  
MR-SPG-UNI-OC

**Boja**  
Chrom



## PODIZAČ FRONTI HORIZON



Šifra: 92792  
GRANIČNIK KUTA  
OTVARANJA PODIZAČA



Šifra	Naziv	GTV kod
92709/M	PODIZAČ HORIZON (MEDIUM) MAX:8-12kg, H=400-650mm, 2 KOM	PD-H-MEDIUM-10
92709/S	PODIZAČ HORIZON (STRONG) MAX:8-12kg, H=400-650mm, 2 KOM	PD-H-STRONG-10
92709/SP	PODIZAČ HORIZON (STRONG PLUS) MAX:8-12kg, H=400-650mm, 2 KOM	PD-H-STRONG-PLUS-10

## PODIZAČ FRONTI STRONG (OTVARANJE NA DODIR)



Šifra	Naziv	GTV kod
92716/M	PODIZAČ MEDIUM PUSH OPEN F1060/2450;250-500mm; 2	PD-LIFT-P2O-MEDIUM-10
92716/S	PODIZAČ STRONG PUSH OPEN F1800-4000; 250-500mm; 2	PD-LIFT-P2O-STRONG-10
92716/PLUS	PODIZAČ STRONG PLUS PUSH OPEN F2600-5000; 600mm; 2	PD-LIFT-P2O-STRONG-PLUS-10

## PODIZAČ FRONTI MINILIFT



Šifra	Naziv	GTV kod
92858/L	MINILIFT NEW LIGHT BEZ USPORIVAČA 2-3 KG KROM	PD-MINILIFTNEW-LIGHT
92858/M	MINILIFT NEW MEDIUM BEZ USPORIVAČA 3,5-4 KG KROM	PD-MINILIFTNEW-MEDIUM
92858/S	MINILIFT NEW STRONG BEZ USPORIVAČA 5-6 KG KROM	PD-MINILIFTNEW-STRONG

# GTV



NOGE ZA STOL  
NOGE ZA NAMJEŠTAJ  
NOGE ZA KUHINJSKE ELEMENTE

**dugatehna**



Šifra	Naziv	GTV kod	Boja
91001/CHROM	NOGICA D-100 CHROM	NM-BD-100-01	Krom
91001/INOX	NOGICA D-100 INOX	NM-BD-100-06	Inox
91001/CRNA	NOGICA D-100 CRNA	NM-BD-100-20	Crna
91002	NOGICA D-150 (SATYNA)	NM-BD-150-02	Satina



Šifra	Naziv	GTV kod	Boja
91077/CHROM	NOGICA D-780 (CHROM)	NM-BD-780-M1	Chrom



Šifra	Naziv	GTV kod	Boja
92733/CRNA	NOGA STOMP, H=120MM CRNA	NM-STGY135-100-20M	Crna



Šifra	Naziv	GTV kod	Boja
92593/CRNA	NOGICA ZA NAMJEŠTAJ STGY-135, h=100mm, CRNA	NM-STGY135-100-20M	Crna
92620/100	NOGICA ZA NAMJEŠTAJ STGY-135, h=100mm, CHROM	NM-STGY135-100-20M	Krom



Šifra	Naziv	GTV kod	Boja
92980/CRNA	NOGICA ZA NAMJEŠTAJ RONDA, H=150 MM, CRNA	NM-RONDA-150-20M	Crna
92980/ZLATO	NOGICA ZA NAMJEŠTAJ RONDA, H=150mm, BRUŠENO ZLATO	NM-RONDA-150-18	Brušeno zlato



Šifra	Naziv	GTV kod	Boja
92981/CRNA	NOGICA ZA NAMJEŠTAJ RONDA SIMPLE, H=150mm, CRNA	NM-RONDA-S-150-20M	Crna
92981/ZLATO	NOGICA ZA NAMJEŠTAJ RONDA SIMPLE, KONZOLNA, H=150mm,	NM-RONDA-S-150-18	Brušeno zlato



Šifra	Naziv	GTV kod	Boja
92982/CRNA	ZA NAMJEŠTAJ ANCHOR, H=150mm, CRNA	NM-ANCHOR-150-20M	Crna



Šifra	Naziv	GTV kod	Boja
92742/100	NOGA ZA NAMJEŠTAJ, 40X40, 100 MM, PRILAGODLJIVA	NM-SQ40ADJ-100	Krom
92909/100	NOGA ZA NAMJEŠTAJ KVADRATNA DAK-27, 40x40/100mm, CRN	NM-DAK27-100-20	Crna



Šifra	Naziv	GTV kod	Boja
91004/60	NOGICA ZA NAMJEŠTAJ DAP-77 60MM ALUMINIJ	NM-DAP77-060	Aluminij
91004/100	NOGICA ZA NAMJEŠTAJ DAP-77 100MM ALUMINIJ	NM-DAP77-100	Aluminij
91004/150	NOGICA DAP-77 150MM (ALUMINIUM)	NM-DAP77-150	Aluminij

## KLASIČNA KUHINJSKA NOGICA

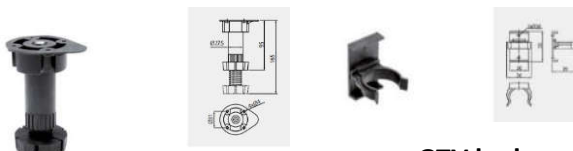

Šifra	Naziv	GTV kod	Boja
91006	NOGICA DP-100 (CRNA PLASTICNA) 95-165 NOSIVOST 60 KG	NM-DPD20-100	Crna
91007	KLIP ZA NOGICU DP-100/150	NM-KL-DPL-20	Crna

## KUHINJSKA NOGICA NOSIVOSTI DO 100 kg



Šifra	Naziv	GTV kod	Boja
92610/100	NOGICA PLASTIČNA ZA NAMJEŠTAJ DPA-100 CRNA 87-120 NOS.	NM-DPA20-100	Crna
92610/150	NOGICA PLASTIČNA ZA NAMJEŠTAJ DPA-150 CRNA 137-170 NO	NM-DPA20-150	Crna



92949	KLJUČ ZA PODEŠAVANJE DPA/DPD KUHINJSKIH NOGU 265 mm	NM-KLUCZREG-DPADPD	Plava
-------	---	--------------------	-------

## KUHINJSKA NOGICA NOSIVOSTI DO 450 kg

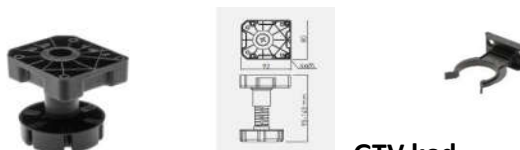

Šifra	Naziv	GTV kod	Boja
92879/50-75	NOGICA S REGULACIJOM KVADR. 50-75 MM, CRNA, NOS.	NM-MLA-50-75	Crna
92879/95-14	NOGICA S REGULACIJOM KVADR. 95-145 MM, CRNA, NOS.	NM-MLA-95-145	Crna
92879/125-1	NOGICA S REGULACIJOM KVADR. 125-195 MM, CRNA, NOS.	NM-MLA-125-195	Crna
92879/NOS	KLIP ZA NOGICU 92879	NM-MLA-KL	Crna

## NOGE ZA STOL



Šifra	Naziv	GTV kod	Boja
91078/CHROM	NOGA 60X710 ZA STOL (CHROM) 710+30	NM-A60710-01	Krom
91078/CRNA	NOGA 60X710 ZA STOL (CRNA) 710+30	NM-A60710-20	Crna
91078/ALU	NOGA 60X710 ZA STOL (ALUMINIUM) 710+30	NM-A60710-05	Aluminij



Šifra	Naziv	GTV kod	Boja
92799/BIJ	NOGA ZA STOL PREKLOPNA I PODESIVA FI40 710+5 BIJELA	NM-X-LINE40710-10	Bijela
92799/CRNA	NOGA ZA STOL PREKLOPNA I PODESIVA FI40 710+5 CRNA	NM-X-LINE40710-20	Crna

Šifra	Naziv	GTV kod	Boja
92715/711	NOGA ZA STOL ARTO, 2 SIPKE 12x711mm CRN NM-ARTO-12-2R711-20M		Mat crna



Šifra	Naziv	GTV kod	Boja
92576/406	NOGA ZA STOL ARTO SA STOPICOM, 3 ŠIPKE, 12 X 406 MM	NM-ARTO-12-3R406-	Mat crna
92576/711	NOGA ZA STOL ARTO SA STOPICOM, 3 ŠIPKE, 12 X 711 MM	NM-ARTO-12-3R711-	Mat crna



**GTV**



**VJEŠALICE**



**dugatehna**



**Šifra**  
91047/A

**Naziv**  
VJESALICA K2343A CHROM)

**GTV kod**  
WZ-A0-K23-01

**Boja**  
Chrom



**Šifra**  
91047/CHROM  
91048/ALUM  
91048/SATYNA

**Naziv**  
VJESALICA K2405A CHROM  
VJESALICA K24 A(ALUMINIUM)  
VJESALICA K24 A(SATYNA)

**GTV kod**  
WZ-A0-K24-01  
WZ-A0-K24-05  
WZ-A0-K24-02

**Boja**  
Chrom  
Aluminij  
Satina



**Šifra**  
92744/02

**Naziv**  
VJEŠALICA K 2405 B, NIKAL

**GTV kod**  
WZ-B0-K24-02

**Boja**  
Nikal



**Šifra**  
91047/SMALL  
91047/CRNA

**Naziv**  
VJESALICA K2343A CHROM) MALA  
VJESALICA K-23B0 CRNA

**GTV kod**  
WZ-B0-K23-01  
WZ-B0-K23-20

**Boja**  
Chrom  
Crna



**Šifra**  
91186

**Naziv**  
VJESALICA WP-2404 (STARO ZLATO)

**GTV kod**  
WZ-00-K24-04

**Boja**  
Staro zlato



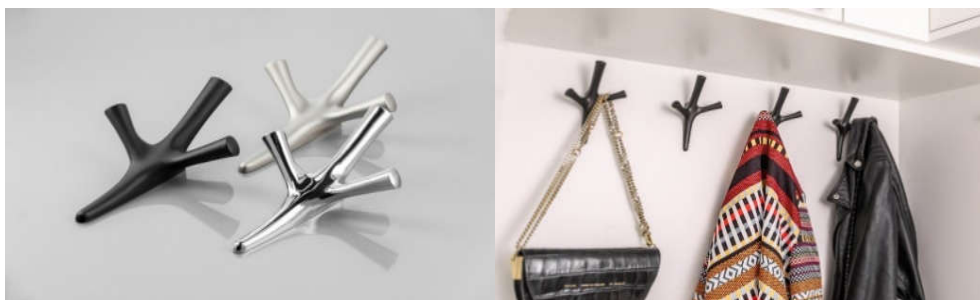

Šifra	Naziv	GTV kod	Boja
92777/CHROM	VJEŠALICA VALENCIA KROM	WZ-WALENCIA-01	Chrom
92777/INOX	VJEŠALICA VALENCIA INOX	WZ-WALENCIA-06	Inox
92777/C.MAT	VJEŠALICA VALENCIA MAT CRNA	WZ-WALENCIA-20M	Mat crna

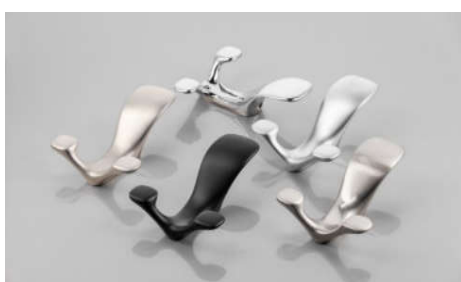

Šifra	Naziv	GTV kod	Boja
91292/CHROM	VJESALICA TOLEDO KROM TRI ZAKAČKE	WZ-TOLED-A0-01	Chrom
92735/C.MAT	VJESALICA TOLEDO A0, CRNI MAT	WZ-TOLED-A0-20M	Mat crna



Šifra	Naziv	GTV kod	Boja
91293/SATYNA	VJESALICA TOLEDO SATEN DVIJE ZAKAČKE	WZ-TOLED-C0-02	Satyn



Šifra	Naziv	GTV kod	Boja
91294/CRNA	VJESALICA TOLEDO CRNA DVIJE ZAKAČKE	WZ-TOLED-B0-20M	Mat crna
91294/INOX	VJESALICA TOLEDO INOX DVIJE ZAKAČKE	WZ-TOLED-B0-06	Inox



**Šifra**  
91270/ALU  
91270/CRNA

**Naziv**  
VJESALICA MALAGA ALUMINIJ DVIJE ZAKAČKE  
VJESALICA MALAGA CRNA DVIJE ZAKAČKE



**GTV kod**  
WA-MALAG-B0-05  
WA-MALAG-B0-20



**Boja**  
Aluminij  
Crna



**Šifra**  
91271/CRNA  
91271/SATIN

**Naziv**  
VJESALICA MALAGA CRNA JEDNA ZAKAČKA  
VJESALICA MALAGA SATINA JEDNA ZAKAČKA



**GTV kod**  
WZ-MALAG-C0-20  
WZ-MALAG-C0-02



**Boja**  
Crna  
Satyn

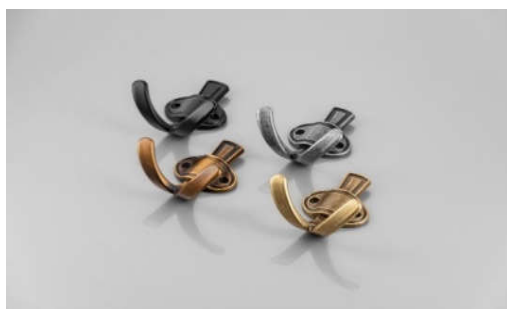

**Šifra**  
91275/A.BRONZ  
91275/BRONZA  
91275/CRNA  
91275/SREBRO

**Naziv**  
VJESALICA CORUNA MINI ANTIQ BRONZA  
VJESALICA CORUNA MINI BRONZA  
VJESALICA CORUNA MINI CRNA  
VJESALICA CORUNA MINI SREBRO



**GTV kod**  
WZ-CORUNA-M-04  
WZ-CORUNA-M-17  
WZ-CORUNA-M-20M  
WZ-CORUNA-M-07

**Boja**  
Antiq Bronza  
Bronza  
Mat crna  
Srebro



**Šifra**  
92895/03  
92895/20M

**Naziv**  
VJEŠALICA TORNA ZLATNA  
VJEŠALICA TORNA MAT CRNA



**GTV kod**  
WZ-TORNA-03  
WZ-TORNA-20M

**Boja**  
Zlato  
Mat Crna



**Šifra**  
91295/CHROM VJESALICA K2202 KROM  
91295/CRNA VJESALICA K2202 CRNA

**GTV kod**  
WZ-K2202-01  
WZ-K2202-CZ

**Boja**  
Chrom  
Crna



**Šifra**  
92647/CRNA VJEŠALICA K2201, JEDNOSTRANA CRNA  
92647/CHR VJEŠALICA K2201, JEDNOSTRANA CHROM

**GTV kod**  
WZ-K2201-CZ  
WZ-K2201-01

**Boja**  
Crna  
Chrom



**Šifra**  
92897/20M VJEŠALICA ARCO MAT CRNA  
92897/18 VJEŠALICA ARCO ČETKANI ČELIK  
92897/06 VJEŠALICA ARCO CHROME

**GTV kod**  
WZ-ARCO-20M  
WZ-ARCO-18  
WZ-ARCO-06

**Boja**  
Mat Crna  
Četk. Zlato  
Četk. Čelik



**Šifra**  
92878/03 VJEŠALICA LENS ZLATO  
92878/06 VJEŠALICA LENS ČETKANI ČELIK

**GTV kod**  
WZ-LENS-03  
WZ-LENS-06

**Boja**  
Zlato  
Četk. Čelik

# GTV



KOTAČI



**dugatehna**



Šifra	Naziv	GTV kod	Boja
92993/BEZ	TOČKIĆ CALIBRO F150 BEZ KOČNICE	KM-CALIBRO-50MM-BH-20	
92993/KOC	TOČKIĆ CALIBRO F150 S KOČNICOM	KM-CALIBRO-50MM-ZH-20	
92992/BEZ	TOČKIĆ CALIBRO F135 BEZ KOČNICE	KM-CALIBRO-35MM-BH-20	
92992/KOC	TOČKIĆ CALIBRO F135 S KOČNICOM	KM-CALIBRO-35MM-ZH-20	



Šifra	Naziv	GTV kod	Boja
91113	KOTAC ZA NAMJESTAJ A PROZIRNI 50 MM	KM-A050MM-00	Transp.
91114	KOTAC ZA NAMJESTAJ A PROZIRNI 50 MM SA KOCNICOM	KM-AH50MM-00	Transp.
91115	KOTAC ZA NAMJESTAJ A PROZIRNI 35 MM	KM-A035MM-00	Transp.
91116	KOTAC ZA NAMJESTAJ A PROZIRNI 35 MM SA KOCNICOM	KM-AH35MM-00	Transp.



Šifra	Naziv	GTV kod	Boja
91208	KOTAC ZA NAMJESTAJ PROZIRNI fi75MM BEZ KOČNICE	KM-B075MM-30	Transp.



Šifra	Naziv	GTV kod	Boja
92989/20M	TOČKIĆ STRADA H=92,5mm, BEZ KOČINICE, CRNI	KM-STRADA-60MM-BH-	CRNA



Šifra	Naziv	GTV kod	Boja
92986/20M	TOČKIĆ BRAZYLIA H=35mm, BEZ KOČINICE, CRNI	KM-RD-35-SF-20	CRNA
92988/20M	TOČKIĆ BRAZYLIA H=35mm, S KOČINICOM, CRNI	KM-RD-35-CF-20	CRNA
92987/20M	TOČKIĆ BRAZYLIA H=50mm, BEZ KOČINICE, CRNI	KM-RD-50-SF-20	CRNA



Šifra	Naziv	GTV kod	Boja
92992/BEZ	TOČKIĆ CALIBRO FI35 BEZ KOČNICE	KM-CALIBRO-35MM-BH-20	CRNA
92992/KOC	TOČKIĆ CALIBRO FI35 S KOČNICOM	KM-CALIBRO-35MM-ZH-20	CRNA
92993/BEZ	TOČKIĆ CALIBRO FI50 BEZ KOČNICE	KM-CALIBRO-50MM-BH-20	CRNA
92993/KOC	TOČKIĆ CALIBRO FI50 S KOČNICOM	KM-CALIBRO-50MM-ZH-20	CRNA



Šifra	Naziv	GTV kod	Boja
91111/BIJELI	KOTAC ZA NAMJESTAJ FI 30MM BIJ.PLASTICNI	KM-015030-10	Bijela
91111/CRNI	KOTAC ZA NAMJESTAJ FI 30MM CRN.PLASTICNI	KM-015030-20	Crna



Šifra	Naziv	GTV kod	Boja
91112/BIJELI	KOTAC ZA NAMJESTAJ FI 38MM BIJELI PLASTICNI	KM-015038-10	Bijela



Šifra	Naziv	GTV kod	Boja
91112/CRNI	KOTAC ZA NAMJESTAJ FI 40MM CRN.PLASTICNI	KM-00-40-D20	Transp.
91008	KOTAC ZA NAMJESTAJ O50(CRNI)	KM-00-50-D20	Crna
91009	KOTAC ZA NAMJESTAJ O50 SA KOČNICOM(CRNI)	KM-0H-50-D20	Crna

# GTV



RASVJETA ZA  
NAMJEŠTAJ

**dugatehna**

## ELEKTRIČNE UTIČNICE

**Šifra** 92623 **Naziv** IZVL.UTIČN.COMFORT PLUS BEŽIČNI PUNJ 120MM 4xSCHU/2xUSB/2xRJ45 **GTV kod** AE-BPW4S120P-20

**Karakteristike:** UGRADBENA IZVLAČNA UTIČNICA, 4 X SCHUKO, USB A+C, BEŽIČNO PUNJENJE, 1 X RJ45, fi145, 1,5m KABEL

**Boja**  
Crna



92616 **STOLNA UTIČNICA COMFORT FI 100, 3 X SCHUCKO, 2 X USB, 1,5 M KABL** AE-BPW3S100U-53

**Karakteristike:** UGRADBENA IZVLAČNA UTIČNICA, 3 X SCHUKO, 2 X USB-A, fi100, 1,5m KABEL

**Boja**  
Aluminij



**Šifra** 92615/PLUS **Naziv** xyUTI CHAR. PLUS 1XSCHU. USB A+C, HDMI, RJ45,WIRELESS KABAL 1,5M **GTV kod** AE-BPW1SACP-20

**Karakteristike:** UGRADBENA UTIČNICA, 1 X SCHUKO, USB A + C, HDMI, RJ45, BEŽIČNO PUNJENJE, KABEL 1,5m

**Boja**

Crna



**Šifra** 92615/1 **Naziv** xyUTIČNICA CHARGER UGRADBENA 1 X SHUCKO, 2XUSB,1,5 M KABLA SIVA **GTV kod** AE-BPW1S2UCH-80

**Karakteristike:** UGRADBENA UTIČNICA, 1 X SCHUKO, 2 X USB, fi 100, KABEL 1,5m

**Boja**

Srebro



**Šifra** 92726 **Naziv** STOLNA UTIČNICA SOFT, 2XSCH+USB A+C, 1,5m KABEL, CRNA **GTV kod** AE-PBSUC2GS-20NN  
**Karakteristike:** UGRADBENA UTIČNICA, 2xSCHUKO, USB A + C, 1,5m KABEL

**Boja:** Crna

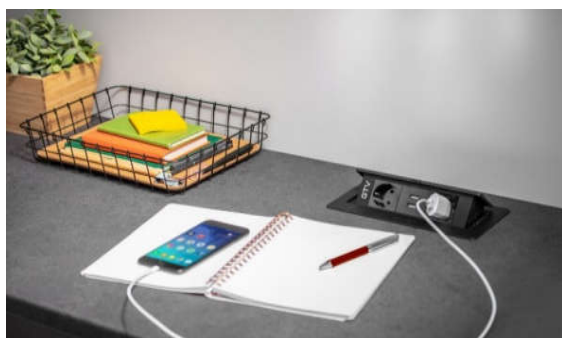

**Šifra** 92728 **Naziv** UTIČNICA SOFT, 3XSCHUKO, AC220-240V, CRNA, 1,5m KABEL **GTV kod** AE-PBSC3GS-20NN  
**Karakteristike:** UGRADBENA UTIČNICA, 3XSCHUKO, 1,5m KABEL  
**Boja:** Crna



**Šifra** 92728/B **Naziv** UTIČNICA SOFT, 3XSCHUKO, AC220-240V, BIJELA 1,5 M KAB **GTV kod** AE-PBSC3GS-10N  
**Karakteristike:** UGRADBENA UTIČNICA, 3XSCHUKO, 1,5m KABEL

**Boja:** Bijela



Šifra	Naziv	GTV kod
92621	xyIZVL. UTIČ. CAMINO BEŽIČNI PUNJAČ/2XSCHUKO/ USB A+C/KABAL 1,5M	AE-BPW2SCAM-20

**Karakteristike:** 2 X SCHUKO, USB A+C, OSVIJETLJENJE, BEŽIČNO PUNJENJE, 1,5m KABEL

**Boja:** Crna



<b>Šifra</b> 92723	<b>Naziv</b> IZVLAČNA UTIČNICA ZA RADNI STOL 60MM, 3X SCHUCKO , CRNA	<b>GTV kod</b> AE-BPW3S60-20
-----------------------	---	---------------------------------

**Karakteristike:** UGRADBENA UTIČNICA, CRNA, 3XSCHUKO, fi60, 1,5m KABEL

**Boja:** Crna



<b>Šifra</b> 91274	<b>Naziv</b> IZVLAČNA UTIČNICA ZA RADNI STOL 60MM, 3XSCHUKO, SIVA	<b>GTV kod</b> AE-BPW3S60-80
-----------------------	--	---------------------------------

**Karakteristike:** UGRADBENA UTIČNICA, SIVA, 3XSCHUKO, fi60, 1,5m KABEL

**Boja:** Aluminij



**Šifra** 92730/CRNA **Naziv** IZVLAČNA UTIČNICA ZA RADNI STOL CRNA 60MM, 3xSCHUKO/2xUSB

**GTV kod**  
AE-BPW3S60U-20

**Karakteristike:** UGRADNA IZVLAČNA UTIČNICA, 3 X SCHUKO, 2 X USB, 1,5m KABEL

**Boja:** Crna



**Šifra** 92730/SIVA **Naziv** IZVLAČNA UTIČNICA ZA RADNI STOL SIVA 60MM, 3X SCHUKO, 2XUSB

**GTV kod**  
AE-BPW3S60U-80

**Karakteristike:** UGRADNA IZVLAČNA UTIČNICA, 3xSCHUKO, 2xUSB, 1,5m KABEL

**Boja:** Siva



## ALUMINIJSKI PROFILI ZA LED TRAKE

Šifra	Naziv	GTV kod	Boja
92700/ALU	UGRADNI SIVI PROFIL ZA LED TRAKU 3m, GLAX	PA-GLAX3M-AL	Aluminij
92700/CRN	UGRADNI CRNI PROFIL ZA LED TRAKU 3m, GLAX	PA-GLAX3M-AL-20M	Crna
92701/ML	POKROV ZA KUTNI I UGRADNI PROFIL, MLIJEČNI 3m, GLAX	PA-OSMLGLAX3M-00	Mliječna
92712/PAK	ZAVRŠNI POKLOPAC ZA GLAX KUTNI PROFIL (10 KOM)	PA-ZASGLAXKT-00	Siva
92704/ALU	KUTNI SIVI PROFIL ZA LED TRAKU 3m, GLAX	PA-GLAXKT3M-AL	Aluminij
92704/CRNA	KUTNI CRNI PROFIL ZA LED TRAKU 3m, GLAX	PA-GLAXNKKT3M-AL-20I	Crna
92702/ALU	NADGRADNI SIVI PROFIL ZA LED TRAKU 3m, GLAX	PA-GLAXMNK3M-AL	Aluminij
92702/CRN	NADGRADNI CRNI PROFIL ZA LED TRAKU 3m, GLAX	PA-GLAXMNK3M-AL-20M	Crna
92703/ML	POKROV ZA NADGRADNI PROFIL, MLIJEČNI 3m, GLAX	PA-OSMLGLAXM3M-00	Mliječni
92702/NOS	NOSAČI ZA NADGRADNI PROFIL GLAX (2 kom)	PA-SPRGLAXM-00	
92711/PAK	ZAVRŠNI POKLOPAC ZA GLAX NADGRADNI PROFIL (10 KOM)	PA-ZASGLAXMNK-00	Siva

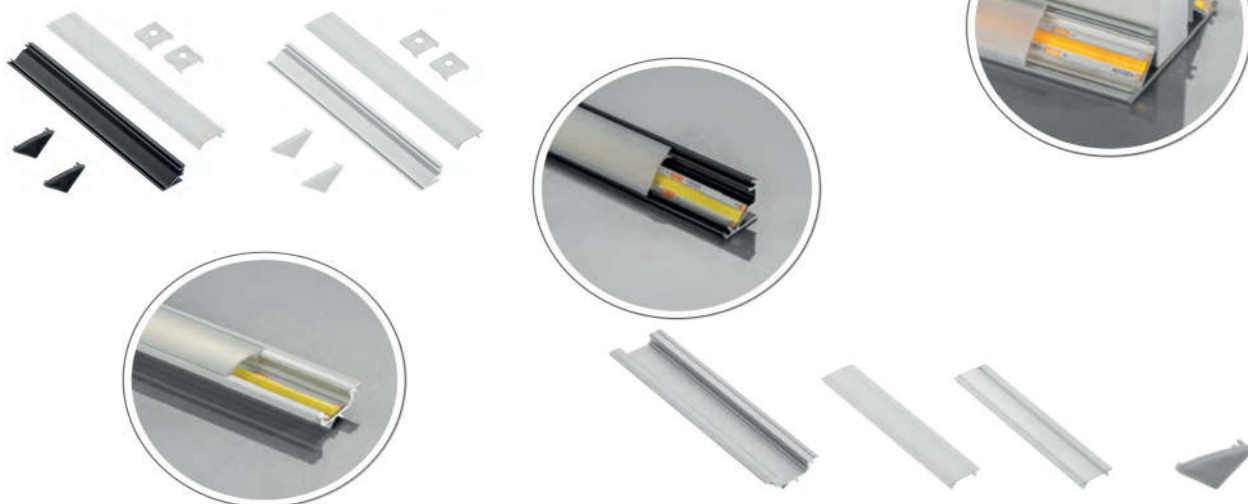

## LED TRAKE I PREKIDAČI

### COB LED TRAKE SA MINI AMP KONEKTORIMA (BEZ LEMLJENJA)

Šifra	Naziv	GTV kod
92856/2700	LED TRAKA COB 2700K,12V, 8W/m, 8mm/5m, miniAMP OBOSTRANO	LD-COB12V-20-CBN
92856/4000	LED TRAKA COB 4000K,12V, 8W/m, 8mm/5m, miniAMP OBOSTRANO	LD-COB12V-20-NEN
92856/6500	LED TRAKA COB 6500K,12V, 8W/m, 8mm/5m, miniAMP OBOSTRANO	LD-COB12V-20-ZBN
92857/4000	LED TRAKA COB 4000K,12V, 10W/m, 8mm/5m, miniAMP OBOSTRANO	LD-COB12V-20-NEPQ
92857/6500	LED TRAKA COB 6500K,12V, 10W/m, 8mm/5m, miniAMP OBOSTRANO	LD-COB12V-20-ZBPQ

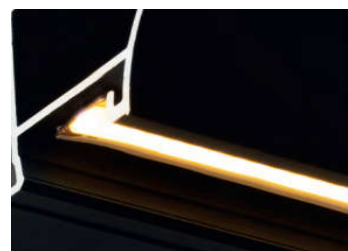
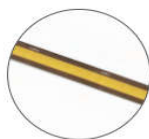

Šifra	Naziv	GTV kod
92793/15W	TRAFO EASY CLICK 15W/1,25A, 4x miniAMP (129x42x16mm)	LD-ZAS15WEC-30
92793/20W	TRAFO EASY CLICK 20W/1,67A, 4x miniAMP (129x42x16mm)	LD-ZAS20WEC-30
92793/30W	TRAFO EASY CLICK 30W/2,5A, 6x miniAMP(160x50x18mm)	LD-ZAS30WEC-30
92793/60W	TRAFO EASY CLICK 60W/5A, 6x miniAMP(190x62x21mm)	LD-ZAS60WEC-30
92793/100W	TRAFO EASY CLICK 100W/8,33A, 6x miniAMP(190x62x21mm)	LD-ZAS100WEC-30



Šifra	Naziv	GTV kod
92893/1	KONEKTOR miniAMP - 1 IZLAZ + 2 M KABAL	LZ-KAPR2M-10
92893/3	KONEKTOR miniAMP - 3 IZLAZA + 2 M KABAL	LZ-AKZ312-10N
92893/5	KONEKTOR miniAMP - 5 IZLAZA + 2 M KABAL	LZ-AKZ612-10N
92922	KONEKTOR COB TRAKE PREMA miniAMP MUSKI	LD-ZTL82MAMP-COB



## PREKIDAČI ZA LED TRAKE

**Šifra**  
92763/DOD

**Naziv**  
PREKIDAČ NA DODIR ZA LED, 12V/24W/fi 22x16mm, CRNI

**GTV kod**  
AE-WDSC-10DIM



**Šifra**  
92791  
92791/AMP

**Naziv**  
PREKIDAČ ZA LED TRAKU PRIPREMLJEN ZA PROFIL 60, 2m  
BESKONTAKTNI PREKIDAČ ZA LED PROFIL S COB/miniAMP KONEKTORIMA 2 AE-WLPRKON-60P200

**GTV kod**  
AE-WLPR-60P2



**Šifra**  
92763/BES

**Naziv**  
PREKIDAČ BESKONTAKTNI INFRACRVENI SENZOR, BIJELI 12V DC

**GTV kod**  
AE-WBEZD-NB

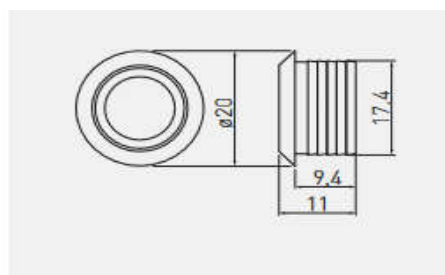

**Šifra**  
92876/B  
92876/C

**Naziv**  
BESKONTAKTNI UGRADNI PREKIDAČ ZA 12/24V, BIJELI  
BESKONTAKTNI UGRADNI PREKIDAČ ZA 12/24V, CRNI

**GTV kod**  
AE-WBBUNI-10DIM  
AE-WBCUNI-10DIM

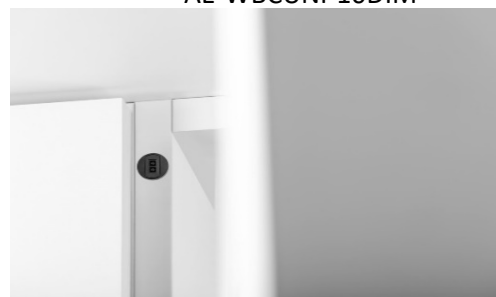

**Šifra**  
92763/PIR

**Naziv**  
PREKIDAČ S DVA SENZORA POKRETA CRNA BOJA

**GTV kod**  
AE-WBEZDPIR2-20



**Šifra**  
92763/PRE  
92763/CRNI

**Naziv**  
PREKIDAČ ZA LED 12V, MAX 36W, BIJELI  
PREKIDAČ ZA LED 12V, MAX 36W, CRNI

**GTV kod**  
AE-WLB01-10



**Šifra**  
92590/4000

**Naziv**  
LED SIJALICA ALVARO 4000K FI65 miniAMP 130lm 1,7W KUT70 2M KABLA

**GTV kod**  
LD-AL24NE-53

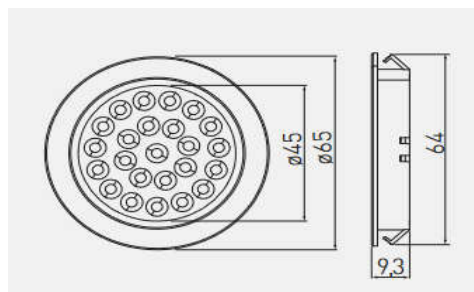

## NOSAČI POLICA



Šifra	Naziv	GTV kod	Boja
-------	-------	---------	------

92605/BAR

NOSAČ POLICE BAR 21x17 CM, CRNA MAT

PP-BAR-20M

Mat crna

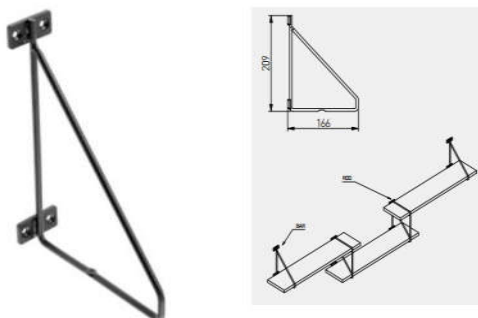

Šifra	Naziv	GTV kod	Boja
-------	-------	---------	------

92605/BELT

NOSAČ POLICE BELT 23 x16 CM, CRNA MAT

PP-BELT-20M

Mat crna

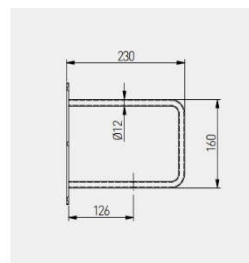

Šifra	Naziv	GTV kod	Boja
-------	-------	---------	------

92605/FLAT

NOSAČ POLICE FLAT 20x20 CM, CRNA MAT

PP-FLAT-20M

Mat crna

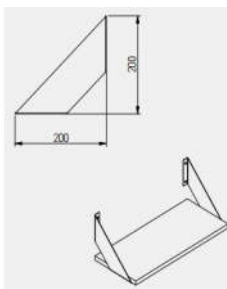

Šifra	Naziv	GTV kod	Boja
-------	-------	---------	------

92605/GALA

NOSAČ POLICE GALA 25x22 CM, CRNA MAT

PP-GALA-20M

Mat crna

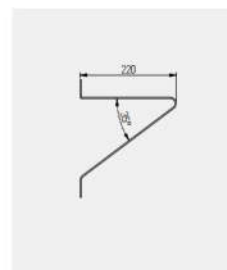



**Šifra**  
92605/ING

**Naziv**  
NOSAČ POLICE INGRID 26x23,4 CM, CRNA MAT

**GTV kod**  
PP-INGRID-20M

**Boja**  
Mat crna

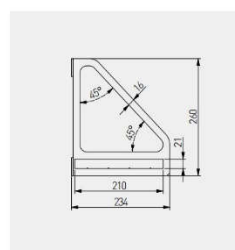

**Šifra**  
92605/ROD

**Naziv**  
NOSAČ POLICE ROD 21x17 CM, CRNA MAT

**GTV kod**  
PP-ROD-20M

**Boja**  
Mat crna

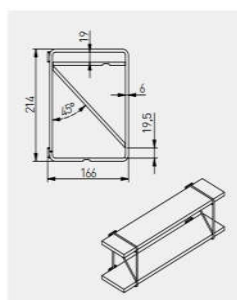

**Šifra**  
92605/TREE

**Naziv**  
NOSAČ POLICE TREE 20x17 CM, CRNA MAT

**GTV kod**  
PP-TREE-20M

**Boja**  
Mat crna

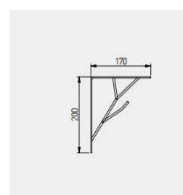



<b>Šifra</b> 92605/WIRE	<b>Naziv</b> NOSAČ POLICE WIRE 18x16 CM, CRNA MAT	<b>GTV kod</b> PP-WIRE-20M	<b>Boja</b> Mat crna
----------------------------	--	-------------------------------	-------------------------

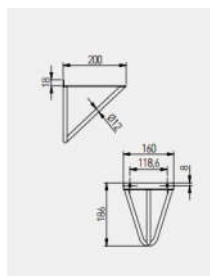

<b>Šifra</b> 92605/GINO	<b>Naziv</b> NOSAČ POLICE GINO 22x20 CM, CRNA MAT	<b>GTV kod</b> PP-GINO-20M	<b>Boja</b> Mat crna
----------------------------	--	-------------------------------	-------------------------

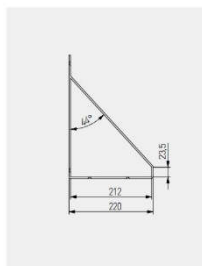

<b>Šifra</b> 92855/12X12	<b>Naziv</b> SKRIVENI NOSAČ POLICE RAVNI 12X120	<b>GTV kod</b> PP-NW12X120B
-----------------------------	--	--------------------------------

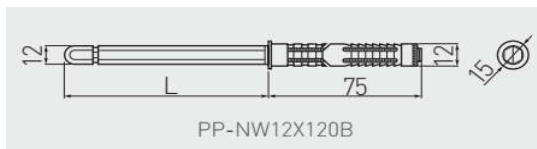

<b>Šifra</b> 92855/12X12	<b>Naziv</b> SKRIVENI NOSAČ POLICE RAVNI 12X120	<b>GTV kod</b> PP-NW12X120B
-----------------------------	--	--------------------------------

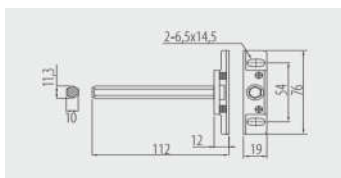

**Šifra** 92765 **Naziv** NOSAČ ZA POLICE L001 "SAFETY" 1000/1 **GTV kod** PP-SPL001-01 **Boja** Inox

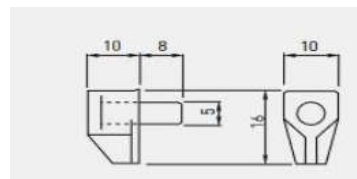

**Šifra** 91145/PAK **Naziv** NOSAČ ZA POLICE L011 "DUPLO" (5000 komada) **GTV kod** MR-TDL011-01 **Boja** Chrom

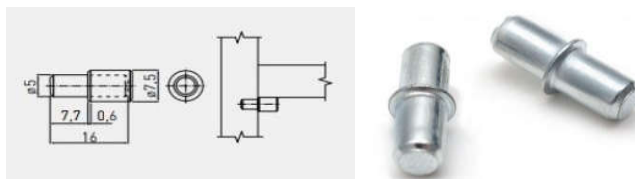

**Šifra** 92891 **Naziv** NOSAČ KUH ELEMENTA S POKL. **GTV kod** KW-FS05-ID-10M **Boja** Bijela



**Šifra** 92577 **Naziv** NOSAČ KUHINJSKIH ELEMENATA S REGULACIJOM BIJELI **GTV kod** ZK-ZAW-R0-10 **Boja** Bijela



**Šifra** 91200/SET **Naziv** NOSAČ KUH. ELEMENATA+PLAST. POKROV (2 KOM) **GTV kod** ZK-R1-KPL-10 **Boja** Bijela



**Šifra** 91146  
91147  
**SILIKONSKI AMORTIZER**

**Šifra** 91205/BIJELI **Naziv** MAGNET (BIJELI) **GTV kod** MG-MENSA-010 **Boja** Bijela  
91205/SMEDJI **Naziv** MAGNET (SMEDJI) **GTV kod** MG-MENSA-030 **Boja** Smeđa



Šifra	Naziv	GTV kod	Boja
91060/CRNI	PLASTIČNI UVODNIK KABLOVA FI=60 CRNI	PM-PLFI60-20	Crna
91060/BIJ	PLASTIČNI UVODNIK KABLOVA FI=60 BIJELI	PM-PLFI60-10	Bijela
91060/ALU	PLASTIČNI UVODNIK KABLOVA FI=60 ALUMINIJ	PM-PLFI60-05	Aluminij



Šifra	Naziv	GTV kod	Boja
91167/ALUMINI	METALNI UVODNIK KABLOVA FI=60 ALUMINIJ	PM-LBFI60-05	Aluminij
91167/SATINA	METALNI UVODNIK KABLOVA FI=60 SATINA	PM-LBFI60-02	Satyna
91167/MAT.C	METALNI UVODNIK KABLOVA FI=60 MAT CRNA	PM-LBFI60-20M	Crna Mat



Šifra	Naziv	GTV kod	Boja
91065/60X485	OTVOR ZA VENTILACIJU 60X484 SIVA	KK-W60800-M0	Siva
92588/BIJE	OTVOR ZA VENTILACIJU 60X484 BIJELI	KK-W60800-M1	Bijela
92588/CRNI	OTVOR ZA VENTILACIJU 60X484 CRNI	KK-W60800-M2	Crna
92588/06	OTVOR ZA VENTILACIJU 60X484 ČETKANI ČELIK	KK-W60800-06	Čet. Čelik
91065/80X480	OTVOR ZA VENTILACIJU 80X480 SIVA	KK-W80800-D0	Siva
92589/BIJE	OTVOR ZA VENTILACIJU 80X480 BIJELI	KK-W80800-D1	Bijela
92589/CRNI	OTVOR ZA VENTILACIJU 80X480 CRNI	KK-W80800-D2	Crna
92589/06	OTVOR ZA VENTILACIJU 80X480 ČETKANI ČELIK	KK-W80800-06	Čet. Čelik

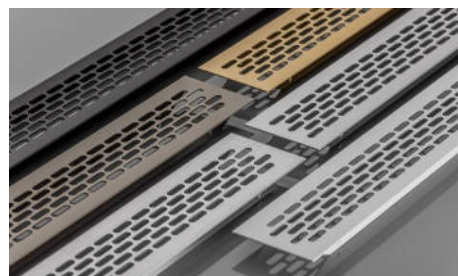

**Šifra**  
91096/138  
91096/CRNA

**Naziv**  
KVADRATNA BRAVICA 138(CHROM)  
KVADRATNA BRAVICA 138, CRNA

**GTV kod**  
ZZ-KM-138N-01-S  
ZZ-KM-138N-20-S

**Boja**  
Chrom  
Crna

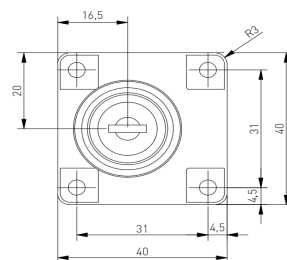

**Šifra**  
92749/5

**Naziv**  
CENTRALNA BRAVICA - 288 L-500 – C5

**GTV kod**  
ZZ-C5-288-01-S

**Boja**  
Chrom

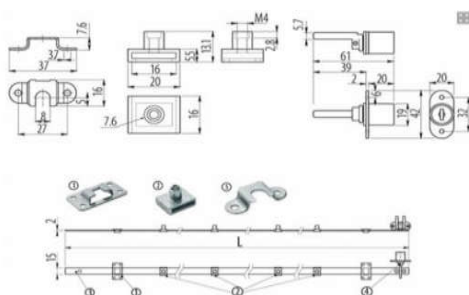

**Šifra**  
91238

**Naziv**  
BRAVICA ZA ŠKRINJU - 103

**GTV kod**  
ZZ-16-103-01-S

**Boja**  
Chrom

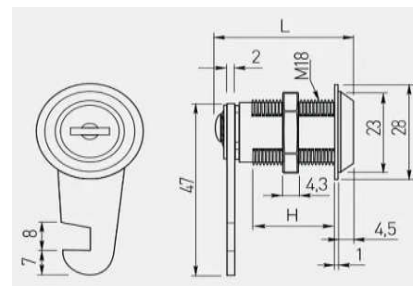

**Šifra**  
91149/2500

**Naziv**  
KONFIRMAT T7x50mm, PAKIRANJE 200 KOMADA

**GTV kod**  
WK-CF0750-01

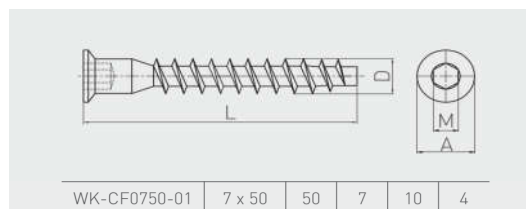

**Šifra**  
92743/35

**Naziv**  
SVRDLO 35 MM S UPUŠTENOM GLAVOM

**GTV kod**  
HT6D320



<b>Šifra</b>	<b>Naziv</b>	<b>GTV kod</b>
92729/2	KUHINJSKA MONTAŽNA ŠINA 2 METRA, 1,25MM	LO-M2M-00-125-A



<b>Šifra</b>	<b>Naziv</b>	<b>GTV kod</b>	<b>Boja</b>
91055/0,8	OVALNA CIJEV 3 METRA - 0,8	RR-CH-OW-000-08	Chrom
91164	OVALNI NOSAC CIJEVI CELIK	MR-RDRO-0000	Chrom
92748	DISTANSNI (STROPNI) DRŽAČ OVALNE CIJEVI	MR-WP-028-01	Chrom

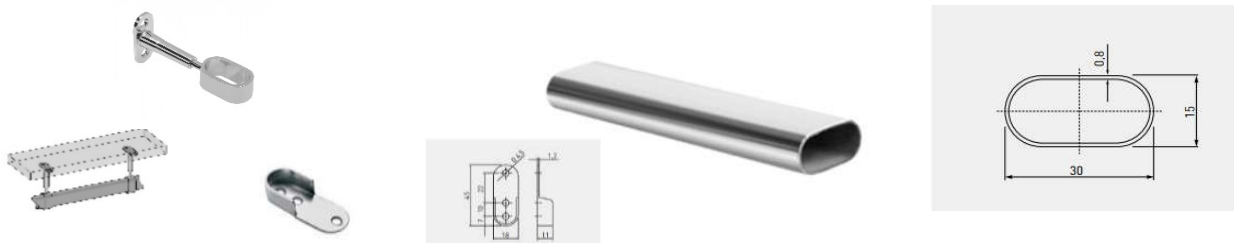

<b>Šifra</b>	<b>Naziv</b>	<b>GTV kod</b>	<b>Boja</b>
92783	PRAVOKUTNA ŠIPKA ZA ODJEĆU GUMIRANA S VRHA L=3m ANTF WG-RRPSET-B-60		Antracit
92784	NOSAČ SA POKLOPCEM ZA PRAVOKUTNU ŠIPKU 92783 ANTRACI WG-RDRP-60		Antracit
92783/CRNA	PRAVOKUTNA ŠIPKA ZA ODJEĆU GUMIRANA S VRHA L=3m ANTF WG-RRPSET-B-20M		Crna
92784/CRNA	NOSAČ SA POKLOPCEM ZA PRAVOKUTNU ŠIPKU 92783/C, WG-RDRP-20M		Crna

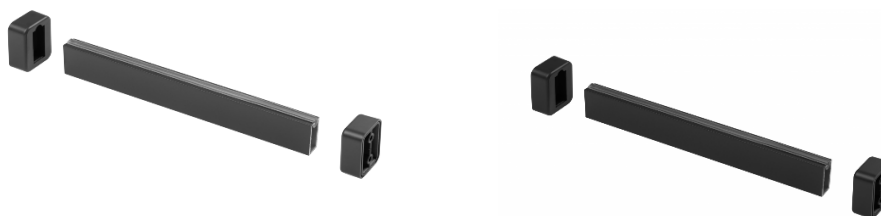

<b>Šifra</b>	<b>Naziv</b>	<b>GTV kod</b>	<b>Boja</b>
92785/45X60	GARDEROBNI LIFT ELITE 545-700, ČELIK- 100 ANTRACIT	PG-ST4560-60	Antracit
92785/60X83	GARDEROBNI LIFT ELITE 60/83, ČELIK- 100 ANTRACIT	PG-ST6083-60	Antracit
92785/83X11	GARDEROBNI LIFT ELITE 83X115, ČELIK- 100 ANTRACIT	PG-ST83115-60	Antracit

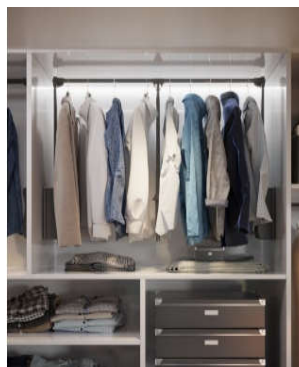

## IZVLAČNE KOŠARE I VJEŠALICE

Šifra	Naziv	GTV kod	Boja
92780/600	METALNA GARDEROBNA KOŠARA ELITE SA TIHIM ZATVARANJEM ELITE 600MM	WG-KOSZM60-60	Antracit
92780/800	METALNA GARDEROBNA KOŠARA ELITE SA TIHIM ZATVARANJEM ELITE 800MM	WG-KOSZM80-60	Antracit



Šifra	Naziv	GTV kod	Boja
92781/600	GARDEROBNA KOŠARA OD RATANA SA TIHIM ZATVARANJEM ELITE 600MM ANT	WG-KOSZR60-60	Antracit
92781/800	GARDEROBNA KOŠARA OD RATANA SA TIHIM ZATVARANJEM ELITE 800MM ANT	WG-KOSZR80-60	Antracit



Šifra	Naziv	GTV kod	Boja
92820/600	GARDEROBNA KOŠARA ELITE TIHO ZATVARANJE 600 MM	WG-KOSZ60-60	Antracit
92820/800	GARDEROBNA KOŠARA ELITE TIHO ZATVARANJE 800 MM	WG-KOSZ80-60	Antracit



92956/800

ORGANIZATOR ZA LADICE ELITE 800mm ANTRACIT

WG-PRZEG80-60-A

Antracit

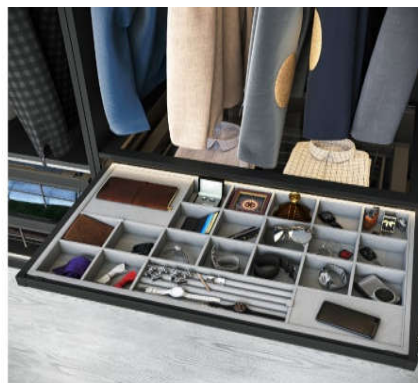

92782/800

IZVLAČNA POLICA ZA HLAČE TIHO ZATVARANJE ELITE 800MM

WG-WSPD80-60

Antracit



**Šifra**

92607/60

92607/80

**Naziv**

VJEŠALICA ZA HLAČE 60 CM (ALU) BEZ VODILICA

VJEŠALICA ZA HLAČE 80 CM (ALU) BEZ VODILICA

**GTV kod**

W-WSPD60-BP-60

W-WSPD80-BP-60



**Šifra**

92734

**Naziv**

VJEŠALICA ZA HLAČE - GORNJI DRŽAČ 340X460X110

**GTV kod**

WW-WSP00-01

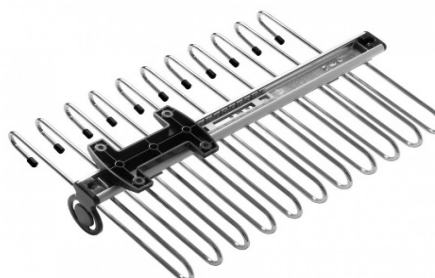

Šifra	Naziv	GTV kod
92645/...	IZVLAČNA VJEŠALICA VELIKA S PLASTIČNOM MONTAŽOM, SHROM	WW-WSD...-01B
Duljine: 250, 300, 350, 400, 450 i 500 mm		



Šifra	Naziv	GTV kod
91091/...	VJESALICA WW-WSL...	WW-WSL...-01
Duljine: 300, 350, 400, 450 i 500 mm		



**Šifra**  
92837/...  
**Naziv**  
BOČNA KOŠARA MOVIX PRO ŽIČANA L=... (BEZ VODILICA)  
**Duljina: 150, 200 i 250 mm**

**GTV kod**  
KO-...BO-01

**Boja**  
Antracit



**VODILICE:** 92838/D (desna)  
92838/L (lijeva)  
92838/O (za 250 mm)

**Šifra**  
92831/...  
92833/...  
**Naziv**  
BOČNA KOŠARA MOVIX PRO CHROM L=...mm (BEZ VODILICA)  
BOČNA KOŠARA MOVIX PRO ANTRACIT L=...MM (BEZ  
**Duljina: 150, 200, 300, 400 i 500 mm**

**GTV kod**

**Boja**  
Chrome  
Antracit



**Šifra**  
92832/L  
92832/D  
92832/O  
**Naziv**  
LIJEVA VODILICA ZA MOVIX BOČNU KOŠARU 150/200mm, TIHO  
DESNA VODILICA ZA MOVIX BOČNU KOŠARU 150/200mm,  
VODILICA ZA MOVIX BOČNU KOŠARU 300/400/500mm, TIHO  
**GTV kod**  
PB-KO450BO-L1  
PB-KO450BO-R1  
PB-KO450BO



<b>Šifra</b> 92731/ANT	<b>Naziv</b> MOVIX PRO IZVLACNI CORNER 450mm ANTRACIT	<b>GTV kod</b> KO-WMC450-60	<b>Boja</b> Antracit
---------------------------	--	--------------------------------	-------------------------



92718/CHR	MOVIX PRO SLIDING KUTNA GARNITURA 450 MM CHROME	KO-UMC450-01	Chrom
-----------	---	--------------	-------



<b>Šifra</b>	<b>Naziv</b>	<b>GTV kod</b>	<b>Boja:</b>
92911/L	PRODUŽENA LADICA-BUBREG-900 LIJEVA RAVNI, ANTRACIT	KN-9-LAP	Antracit
92911/D	PRODUŽENA LADICA-BUBREG-900 DESNA RAVNI, ANTRACIT	KN-9-RAP	Antracit
92912/L	PRODUŽENA LADICA-BUBREG-900 LIJEVA RAVNI, CHROM	KN-9-LCP	Krom
92912/D	PRODUŽENA LADICA-BUBREG-900 DESNA RAVNI, CHROM	KN-9-RCP	Krom



Šifra 92653 Naziv SEGREGATOR MULTINO NEW 600, 3X15L + 1X7L ANTRACIT GTV kod PB-93004162601 Boja Antracit

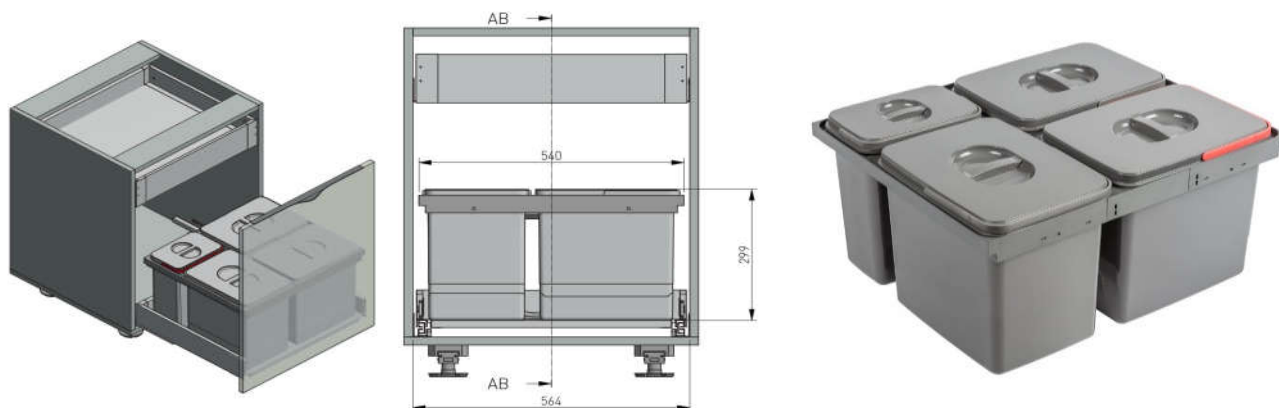

Šifra 92878 Naziv SEGREGATOR OTPADA MULINO 800 MM 3X15 L + 3 POSUDE AN PB-91634100B5V-A Boja Antracit

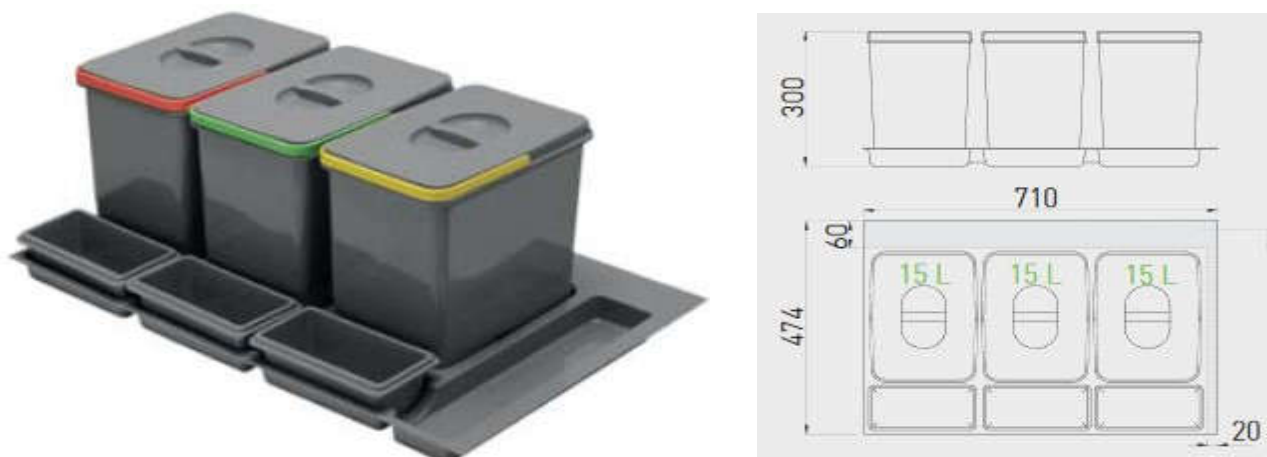

Šifra 92871 Naziv SEGREGATOR OTPADA 300MM 10 L + 20 L ANTRACIT S VOD. TIHO ZAT H45 GTV kod PB-45-002010-60A Boja Antracit

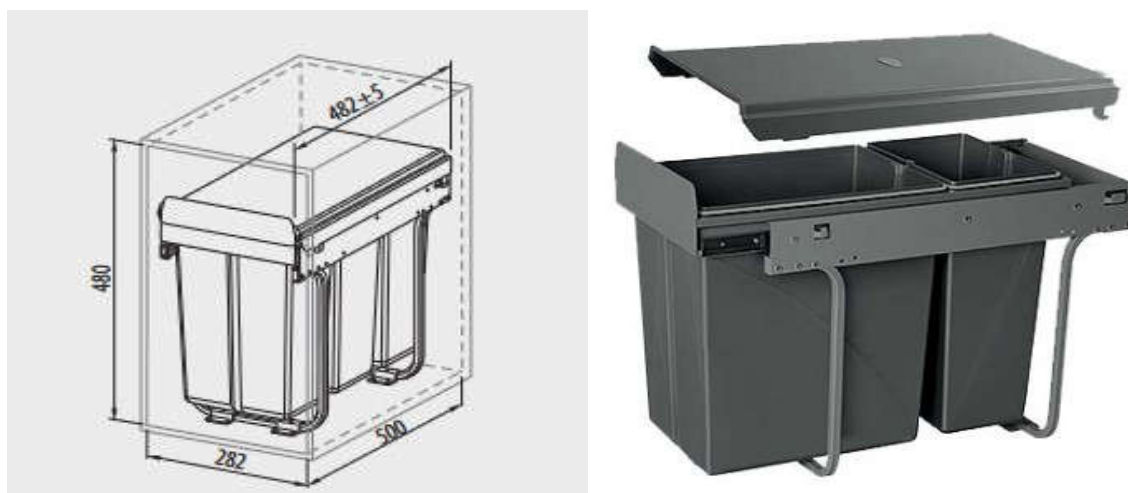

<b>Šifra</b> 92882	<b>Naziv</b> SEGREGATOR OTPADA 400MM 2X20 L ANTRACIT MONT FRONT	<b>GTV kod</b> PB-45-MF002X20-60A	<b>Boja</b> Antracit
-----------------------	---	--------------------------------------	-------------------------

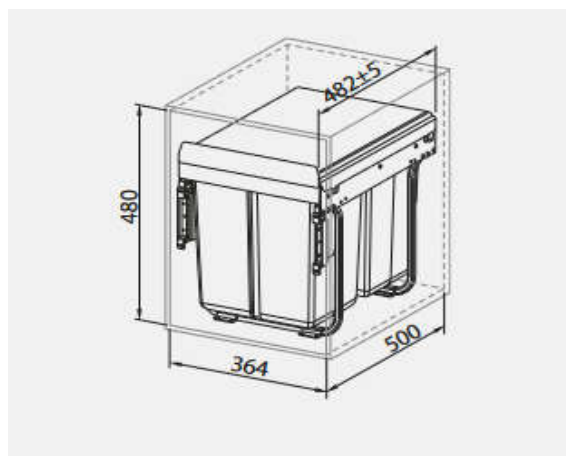

<b>Šifra</b> 92882/2x10	<b>Naziv</b> SEGREGATOR OTPADA ZA 400mm, 20+2X10L, H45, PREDNJA MONT, ANTRACIT	<b>GTV kod</b> PB-45-MF202X10-60A	<b>Boja</b> Antracit
----------------------------	--	--------------------------------------	-------------------------

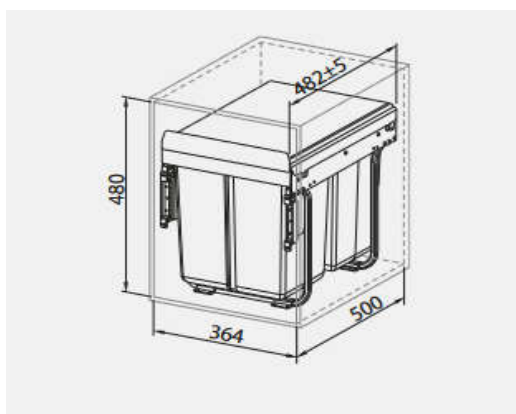

<b>Šifra</b> 92877	<b>Naziv</b> SEGREGATOR OTPADA 450MM 2x15 L ANTRACIT S VOD TIHO ZATV	<b>GTV kod</b> PB-45-002X15-60A	<b>Boja</b> Antracit
-----------------------	--	------------------------------------	-------------------------

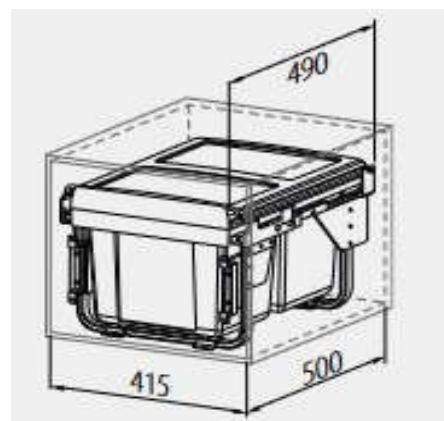

Šifra	Naziv	GTV kod	Boja
92884	SEGREGATOR OTPADA 450MM 2X20 L ANTRACIT MONT FRONT	PB-45-MF2X20-60A	Antracit

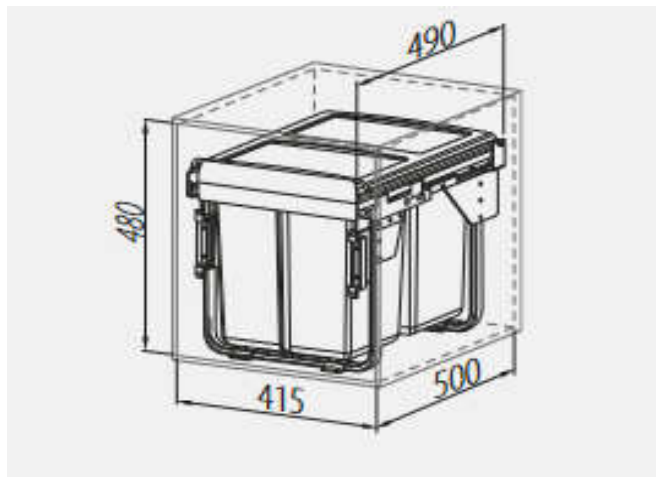

Šifra	Naziv	GTV kod	Boja
92870	SEGREGATOR OTPADA 600MM 2X27 L ANTRACIT S VOD TIH ZAT PB-45-600MF-2X27-60A	PB-45-600MF-2X27-60A	Antracit

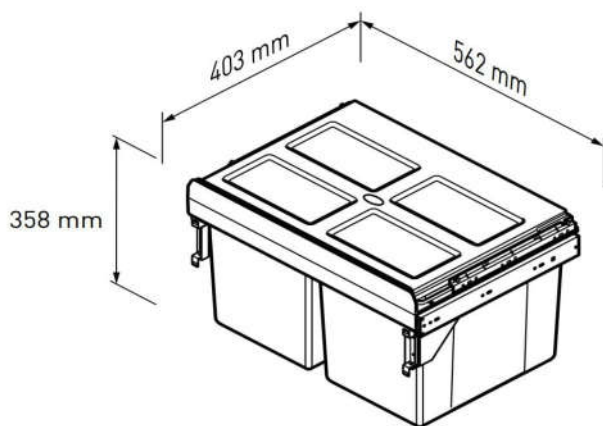

# GTV



## VELLO SUSTAV BEZ RUČKI

[gtv.com.pl](http://gtv.com.pl)

**dugatehna**



## Horizontalni L – profil

Profil se montira izravno ispod radne površine. LED profil omogućuje osvjetljavanje unutrašnjosti gornjih ladica i ormarića ispod profila.



**ŠIFRA: 92753**

profil

C mm	L mm						
cut	3000	aluminij	brushed steel	bijeli	black matt	aluminij	12
	4100	PA-VELLO-L3M-05	PA-VELLO-L3M-06	PA-VELLO-L3M-10	PA-VELLO-L3M-20M		
		PA-VELLO-L4M-05	PA-VELLO-L4M-06	PA-VELLO-L4M-10	PA-VELLO-L4M-20M		

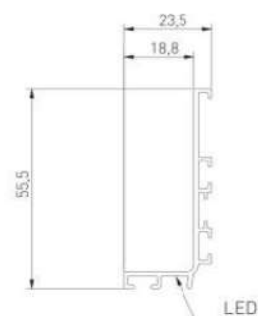



## Horizontalni C – profil

Savršen za montažu između dvije ladice, što nam daje mogućnost otvaranja ladica odozgo ili odozdo. Zahvaljujući LED funkciji možete osvijetliti unutrašnjost ladice koja se nalazi ispod profila.



ŠIFRA: 92754

profil

C	L	Boja	LED	LED	LED	LED	LED
3000	3000	BELO	BELO	BELO	BELO	BELO	BELO
3000	3000	BELO	BELO	BELO	BELO	BELO	BELO
3000	3000	BELO	BELO	BELO	BELO	BELO	BELO
3000	3000	BELO	BELO	BELO	BELO	BELO	BELO
3000	3000	BELO	BELO	BELO	BELO	BELO	BELO





## Pojedinačni vertikalni T – profil

Profil konstruiran za otvaranje bez ručke masivnih ormara. Otvora jedan ormar.



ŠIFRA: 92755

profil

Šifra	Boja	Šifra	Boja	Šifra	Boja	Šifra	Boja
92755	aluminij	92756	brusnati ormar	92757	bež	92758	črna mat
PA-VELLO-T20M-01	PA-VELLO-T20M-02	PA-VELLO-T20M-03	PA-VELLO-T20M-04	PA-VELLO-T20M-05	PA-VELLO-T20M-06	ALUMINIJ	0



## Dvostruki vertikalni T – profil

Profil konstruiran za otvaranje bez ručke ormara za teret. Dvostruki profil otvara dva neovisna ormara.



ŠIFRA: 92756

profil

Šifra	Boja	Šifra	Boja	Šifra	Boja	Šifra	Boja
92756	aluminij	92757	brusnati ormar	92758	bež	92759	črna mat
PA-VELLO-T20M-01	PA-VELLO-T20M-02	PA-VELLO-T20M-03	PA-VELLO-T20M-04	PA-VELLO-T20M-05	PA-VELLO-T20M-06	ALUMINIJ	0



## Montaža Vello sustava



PA-MOUNT-GL-00

ŠIFRA: 92753/NOS

Sustav omogućuje montažu horizontalnih C i L profila kako na unutarnju stranu zidova ormara tako i na pregrade. U montaži se također može koristiti spajanje dva profila vodoravno pod pravim kutom.

Set se sastoji od 2 pričvršćivača i 8 vijaka M4 (4 vijaka po jednom fiksiranju). Dva kosa otvora koriste se za montažu ručke vijcima na panele namještaja (nisu uključeni za pričvršćivanje). Pakiranje – 50 kompleta (2 kom.) u jednom pakiranju.

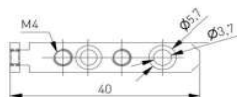
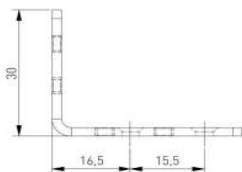

## Krunski profil

Glatka linija ormarića može se postići montažom GLAX krunskog profila na donji rub. Riječ je o proizvodu dva u jednom koji zamjenjuje ručku i istovremeno osvjetljava radnu ploču.

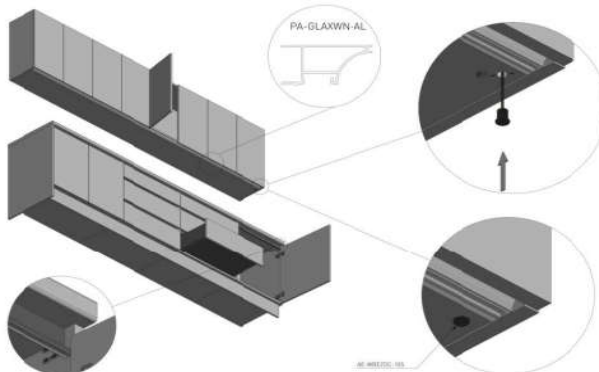

Šifra	Opis	Boja	Profil	Profil	Profil
PA-GLAXWN-AL		2		trajerni	
PA-GLAXWN-AL				stani	aluminij
PA-GLAXWNM-AL-20M	16	3	profil	stani	
PA-GLAXWNM-AL-10				stani	
PA-GLAXWNM-AL-05				stani	
PA-OSMGLAX-00	-	2		mijačna	
PA-OSTRGLAX-00	-		završnica	transparentno	PC
PA-OSMGLAXM-00	-			trajerni	
PA-OSTRGLAXM-00	-	3		transparentno	
PA-URZGLAX-05M	-	10		stani	EPSM
PA-URZGLAX-10M	-			stani	

ŠIFRA: 92757

Za profil se može koristiti bilo koja GTV Lihtina traka s pokrovkom.

Šifra	Opis	Boja
PA-GLAXWN-AL	Aluminijski profil GLAX, ugrađeno 2 metra	
PA-GLAXWNM-00	Aluminijski profil GLAX, ugrađeno 3 metra	
PA-GLAXWNM-20M	Aluminijski profil GLAX, ugrađeno 2 metra	
OS-GLAXWNM-00	Aluminijski profil GLAX, ugrađeno 3 metra	
GL-GLAXWNM-00	Aluminijski profil GLAX, ugrađeno 3 metra	

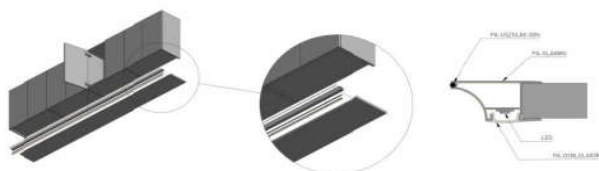

## Vello sustav zatvaranja

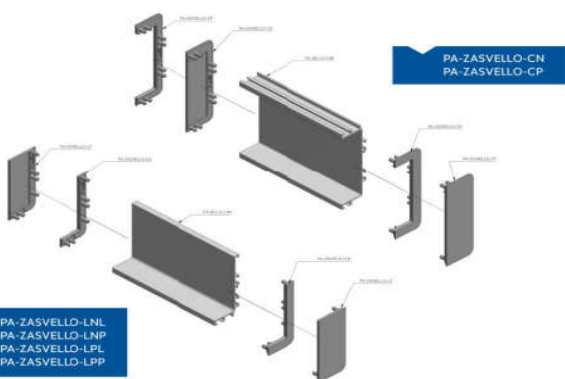

PA-ZASVELLO-LNL  
PA-ZASVELLO-LNP  
PA-ZASVELLO-LPL  
PA-ZASVELLO-LPP

Završne poklopce proizvodimo tehnologijom 3D printanja, nakon čega slijedi bojanje u istu boju profila. Kod L-profila imamo desni i lijevi završni poklopac, u punoj i otvorenoj verziji. Poklopac za C-profil je simetričan, dostupan u punoj i otvorenoj verziji.

Svaka vrsta poklopca dostupna je u četiri verzije boja koje odgovaraju profilu.

### Završni poklopci za L profil

Šifra	Opis	Boja	Profil	Profil
PA-ZASVELLO-LNL-05	PA-ZASVELLO-LNL-05	PA-ZASVELLO-LNL-10	PA-ZASVELLO-LNL-10	PA-ZASVELLO-LNL-20M
PA-ZASVELLO-LNP-05	PA-ZASVELLO-LNP-05	PA-ZASVELLO-LNP-10	PA-ZASVELLO-LNP-10	PA-ZASVELLO-LNP-20M
PA-ZASVELLO-LPL-05	PA-ZASVELLO-LPL-05	PA-ZASVELLO-LPL-10	PA-ZASVELLO-LPL-10	PA-ZASVELLO-LPL-20M
PA-ZASVELLO-LPP-05	PA-ZASVELLO-LPP-05	PA-ZASVELLO-LPP-10	PA-ZASVELLO-LPP-10	PA-ZASVELLO-LPP-20M

ŠIFRA: 92852  
92853  
92854

### Završni poklopci za C profil

Šifra	Opis	Boja	Profil	Profil
PA-ZASVELLO-CN-05	PA-ZASVELLO-CN-05	PA-ZASVELLO-CN-10	PA-ZASVELLO-CN-10	PA-ZASVELLO-CN-20M
PA-ZASVELLO-CP-05	PA-ZASVELLO-CP-05	PA-ZASVELLO-CP-10	PA-ZASVELLO-CP-10	PA-ZASVELLO-CP-20M

## Završni poklopci

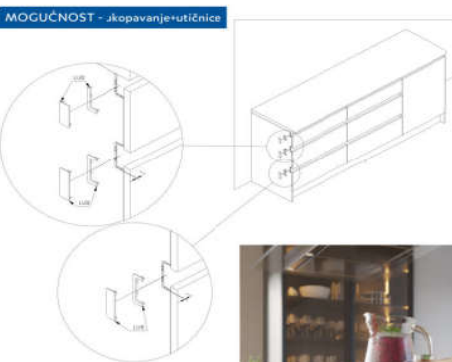

### Dimenzije glodanja za profile

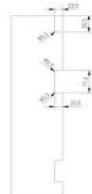

# GTV

## SUSTAV KLIZNIH VRATA ZA PLAKARE



**dugatehna**

Šifra	Naziv	GTV kod	Boja
92550/3	ALU. PROFIL (GORNJA VODILICA), L=3M ALUMINIJ	A-TG-300-05	Aluminij
92550/4,05	ALU. PROFIL (GORNJA VODILICA), L=4,05M	A-TG-405-05	Aluminij
92802/3	ALU. PROFIL (GORNJA VODILICA), L=3M MAT CRNA	A-TG-300-20M	Crna
92802/4,05	ALU. PROFIL (GORNJA VODILICA), L=4,05m MAT CRNA	A-TG-405-20M	Crna

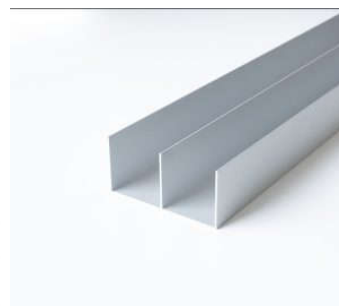
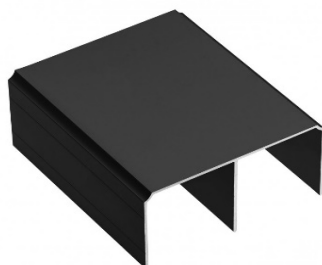
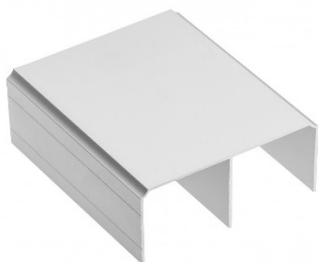

Šifra	Naziv	GTV kod	Boja
92803/3	ALU. PROFIL PRO (DONJA VODILICA), L=3M ALUMINIJ	A-TDPRO-300-05	Aluminij
92803/4,05	ALU. PROFIL PRO (DONJA VODILICA), L=4,05M ALUMINIJ	A-TDPRO-405-05	Aluminij
92804/3	ALU. PROFIL PRO (DONJA VODILICA), L=3M MAT CRNA	A-TDPRO-300-20M	Crna
92804/4,05	ALU. PROFIL PRO (DONJA VODILICA), L=4,05m MAT CRNA	A-TDPRO-405-20M	Crna

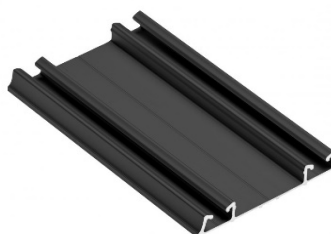

Šifra	Naziv	GTV kod	Boja
92828	ELEMENTI ZA VRATA PLAKARA (2 GORNJA I DONJA, STOPER) SETA-ROLL-PRO-G-SET		Aluminij



**Šifra** 92813/50 **Naziv** AUTOMAT SOFT CLOSE ZA ZATV. VRATA PLAKARA SET 2 KOM 50 KG **GTV kod** A-SOFT-50Z

92810/SIRO  
ČETKA DISTANCER ZA PLAKAR 14,5 X 4MM 200 M



**Šifra** 92810/USKA  
92810/SIRO **Naziv** ČETKA DISTANCER ZA PLAKAR 4,8 X 4MM 200 M  
ČETKA DISTANCER ZA PLAKAR 14,5 X 4MM 200 M

**GTV kod** A-SO-R-48X4  
A-SO-R-145X4 **Boja** Siva  
Siva

**Šifra** 92564/2,7 **Naziv** PROFILNA RUČKICA ERGO L=2,7M ALUMINIJ

**GTV kod** A-R18ERG-270-05 **Boja** Aluminij



## ERGO

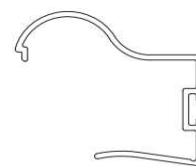

**Šifra** 92582/05  
92582/20 **Naziv** PROFILNA RUČKICA STEP L=2,7M ALUMINIJ  
PROFILNA RUČKICA STEP L=2,7M CRNA MAT

**GTV kod** A-R18STEP-270-05  
A-R18STEP-270-20M **Boja** Aluminij  
Mat crna

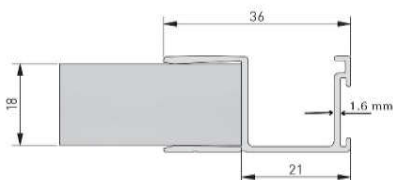

# GTV

## QUANTUM - sustav za pregrade



**Preporuka:**  
1 x 92752/SET  
1 x 92752/SINA  
3 x 92752/N.SIN  
2 x 92752/N.VR

**Šifra**  
92752/SET

**Naziv**  
QUANTUM SET: 2 KOLICA, 2, ČEPA, 2 VODILICE I VIJCI

**GTV kod**  
A-BUDP-SET



**dugatehna**

<b>Šifra</b> 92752/SINA	<b>Naziv</b> QUANTUM GORNJA VODILICA 2M	<b>GTV kod</b> A-TG-BUD-200-00
----------------------------	--	-----------------------------------



<b>Šifra</b> 92752/N.SIN	<b>Naziv</b> QUANTUM NOSAČ ŠINE	<b>GTV kod</b> A-BUD-K-UB
-----------------------------	------------------------------------	------------------------------



<b>Šifra</b> 92752/N.VR	<b>Naziv</b> QUANTUM NOSAČ VRATA	<b>GTV kod</b> A-BUD-UP
----------------------------	-------------------------------------	----------------------------



# GTV



## GTV

**Ručkice za namještaj**



**dugatehna**

## EXTEND



ŠIFRA: 92899

10M	20M	22M	23
biały, white, finiś, fehér	czarny mat, black matt, чорний матовий, fekete matt	złoty, gold, золотий, arany	kaszmir, cashmere, кашмирский, kasmirszinő
UA-EXTEND-1200-10M	UA-EXTEND-1200-20M	UA-EXTEND-1200-22	UA-EXTEND-1200-23*



## HEXA LONG



ŠIFRA: 92923

05	10M	20M	22	23	06
aluminium, aluminium, алюминий, aluminium	biały mat, white matt, белый матовый, fehér matt	czarny mat, black matt, чёрный матовый, fekete matt	jasne złoto szczotkowane, bright brushed gold, светлая шлифованная золото, arany	kaszmir, cashmere, кашмирский, kasmirszínű	inox, inox, шлифованная сталь, inox
UA-HEXA-1200-05	UA-HEXA-1200-10M	UA-HEXA-1200-20M	UA-HEXA-1200-22	UA-HEXA-1200-23	UA-HEXA-1200-06

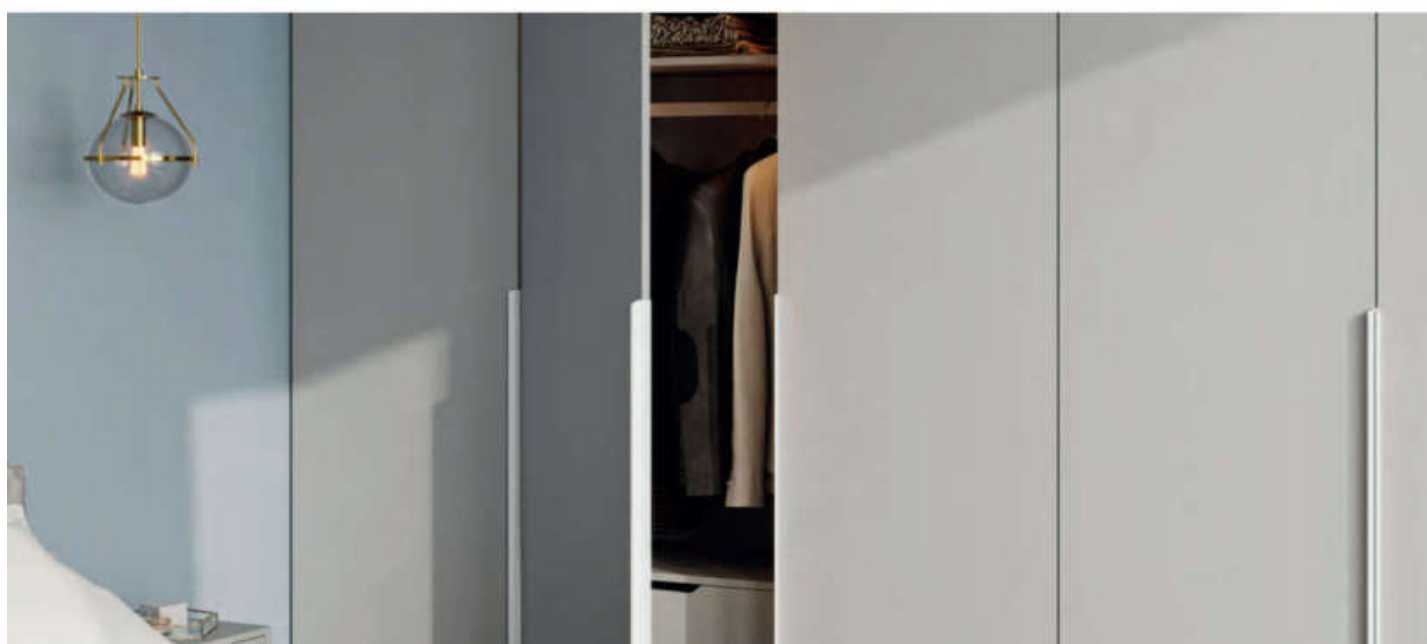

## PILLAR LONG

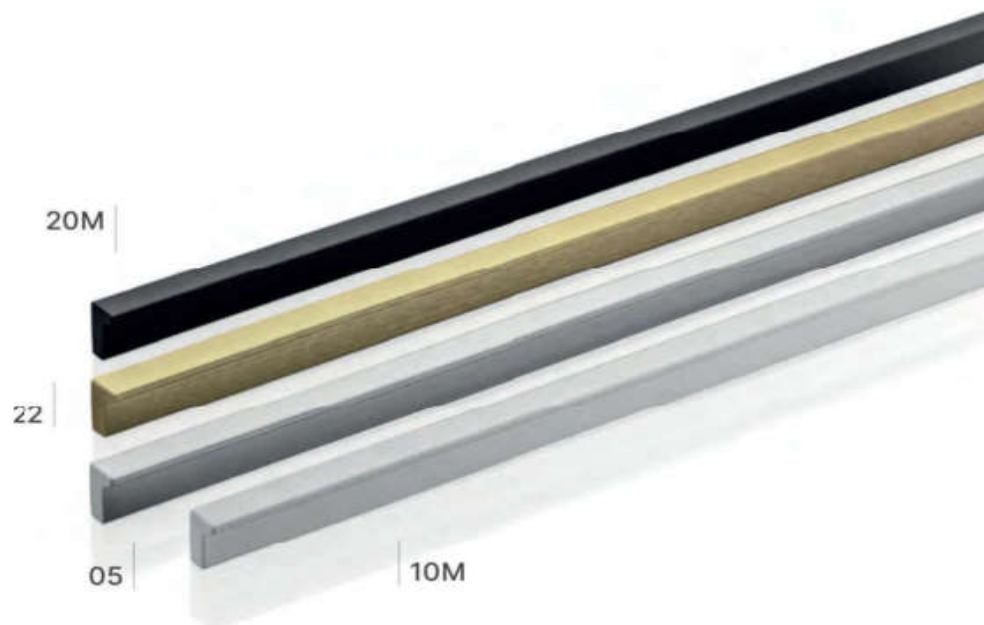

ŠIFRA: 92944

05	20M	10M	22
aluminium, aluminium, алюміній, aluminium	czarny mat, black matt, чорний матовий, fekete matt	bialy mat, white matt, білий матовий, fehér matt	jasne zioto szczotkowane, bright brushed gold, світле шліфоване золото, arany
UA-PILLAR-1200-05	UA-PILLAR-1200-20M	UA-PILLAR-1200-10M	UA-PILLAR-1200-22

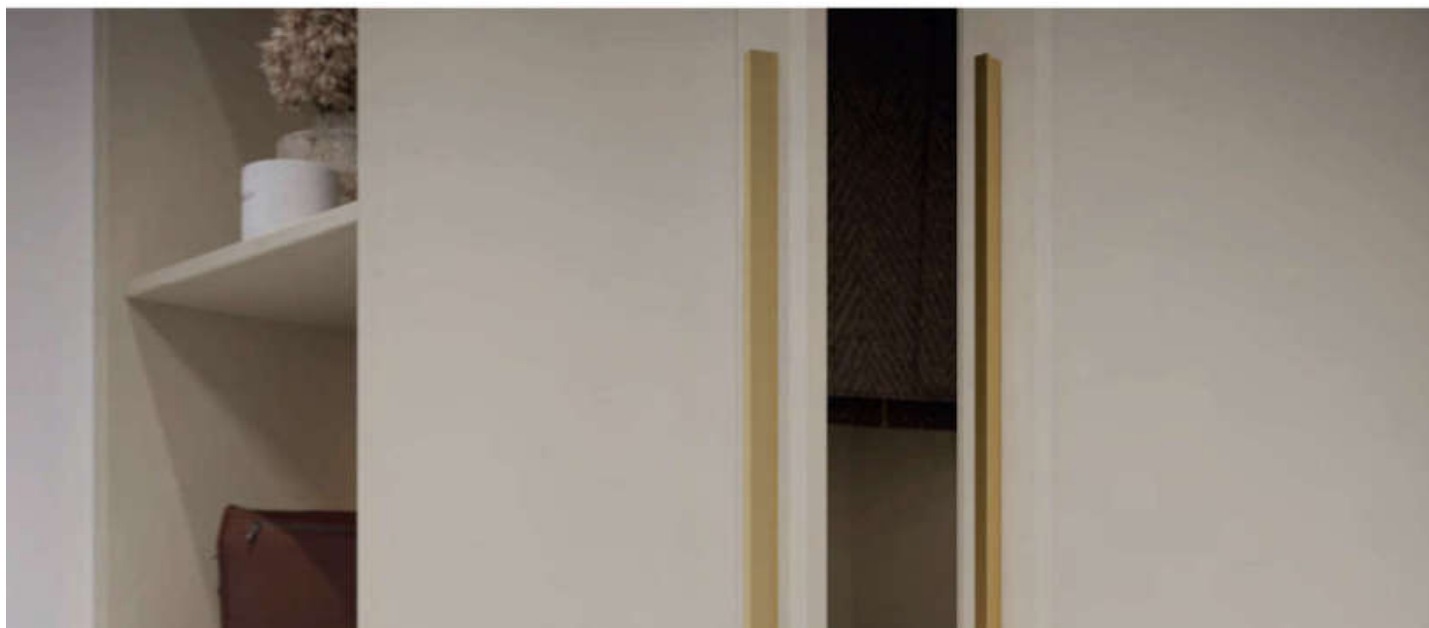

## GRAVEL LONG

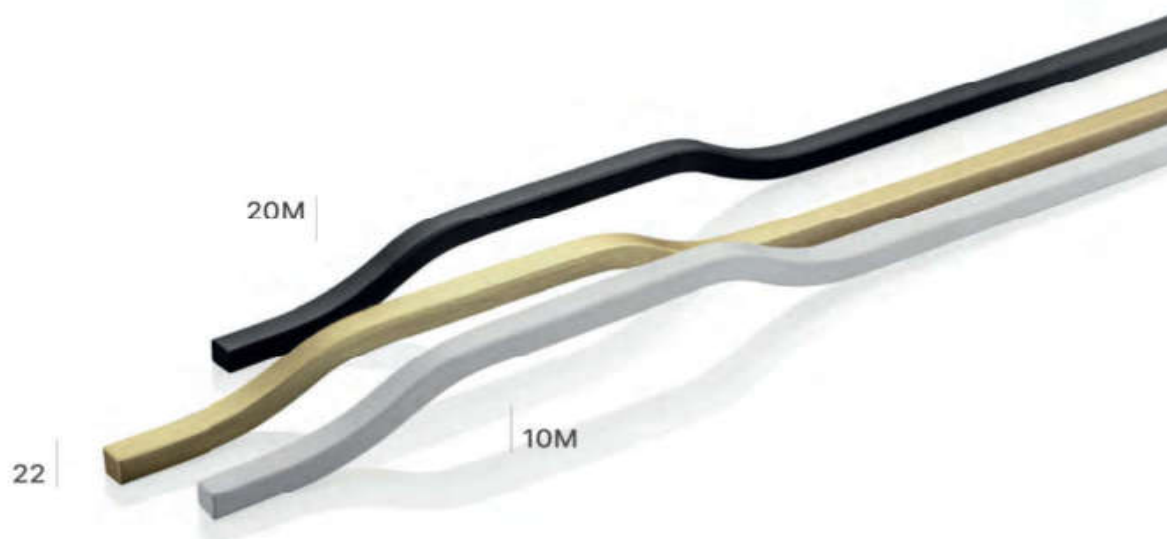

ŠIFRA: 92943

20M	10M	22
czarny mat, black matt, чорний матовий, fekete matt	biały mat, white matt, білий матовий, fehér matt	jasne złoto szczerkowane, bright brushed gold, світле шліфоване золото, afany
UA-GRAVEL-1200-20M	UA-GRAVEL-1200-10M	UA-GRAVEL-1200-22

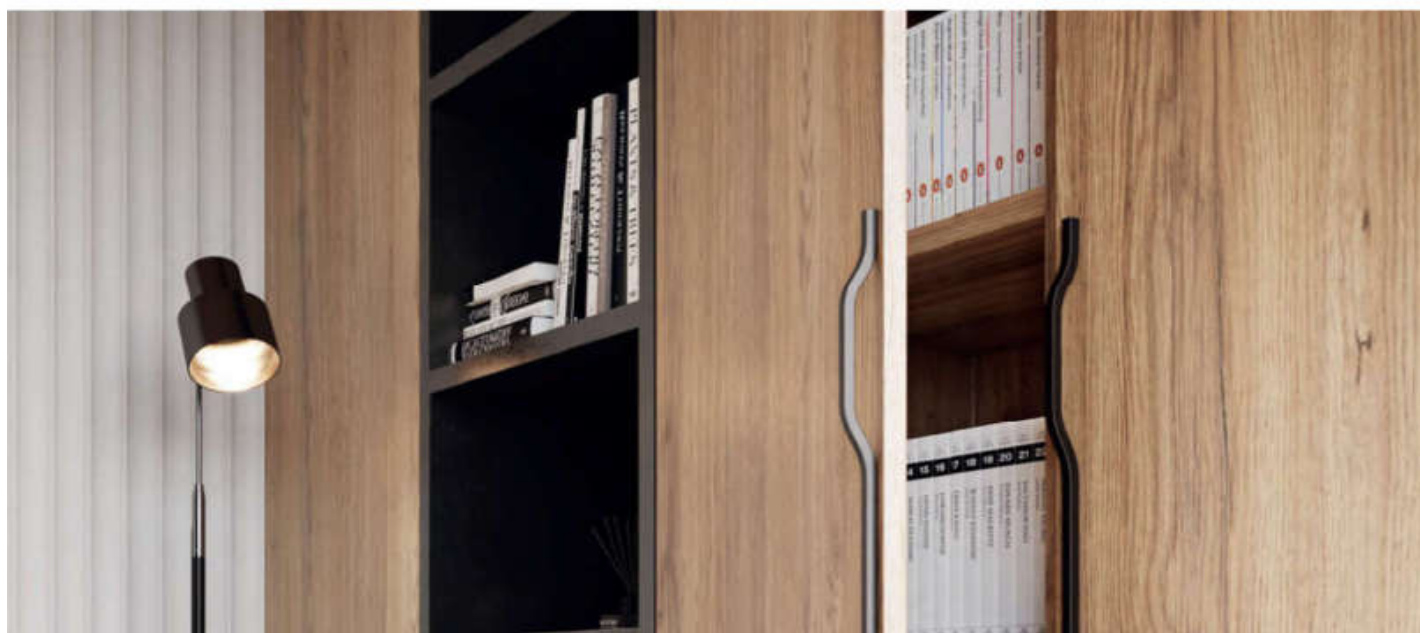

# GTV

GTV

## OCTAVIO



ŠIFRA: 92738  
92739



**dugatehna**

## UZ-819

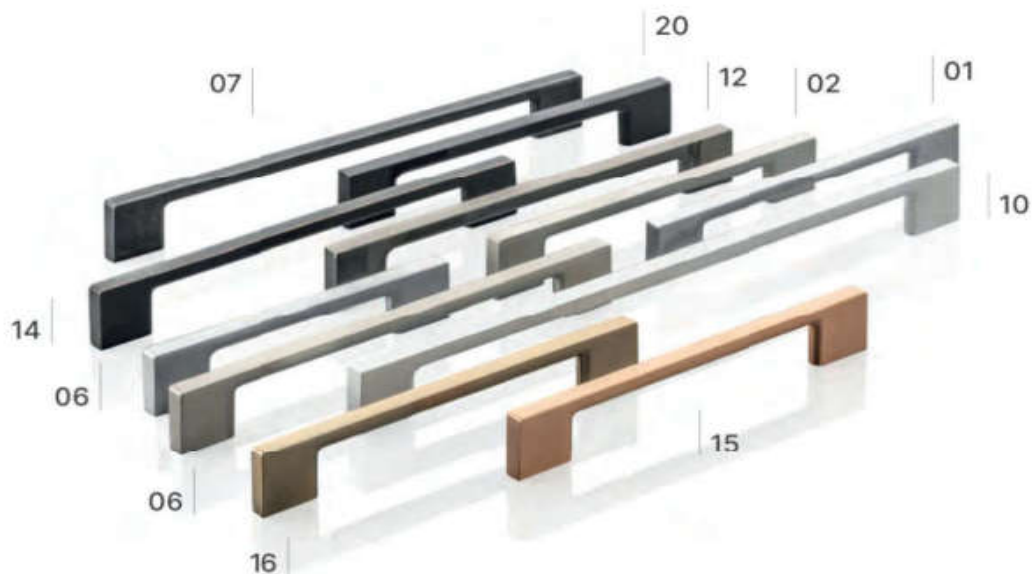

ŠIFRA: 91231  
91272  
92618  
92618  
92873  
92874

01	02	05	06	07
chrom, chrome, хром, króm	satyna, satin, сатин, szatén	aluminium, aluminium, алюминий, aluminium	stal szczotkowana, brushed steel, шліфована сталь, szálciszolt acél	antyczne srebro, antique silver, античне срібло, antik ezüst
UZ-819096-01	UZ-819096-02	UZ-819096-05	UZ-819096-06	UZ-819096-07
UZ-819128-01	UZ-819128-02	UZ-819128-05	UZ-819128-06	UZ-819128-07
UZ-819160-01	UZ-819160-02	UZ-819160-05	UZ-819160-06	UZ-819160-07
UZ-819192-01	UZ-819192-02	UZ-819192-05	UZ-819192-06	UZ-819192-07
UZ-819256-01	UZ-819256-02	UZ-819256-05	UZ-819256-06	UZ-819256-07
UZ-819320-01	UZ-819320-02	UZ-819320-05	UZ-819320-06	UZ-819320-07

10	12	14	15	16	20
biały, white, білий, fehér	czarny, chrom, black, chrome, чорний, хром, fekete, króm	antyczna miedź, antique copper, антична мідь, antik réz	miedź, copper, мідь, réz	złoty mosiądz, gold brass, золота латунь, aranyréz	czarny, black, чорний, fekete
UZ-819096-10	UZ-819096-12	UZ-819096-14	-	-	UZ-819096-20
UZ-819128-10	UZ-819128-12	UZ-819128-14	UZ-819128-15	UZ-819128-16	UZ-819128-20
UZ-819160-10	UZ-819160-12	UZ-819160-14	UZ-819160-15	UZ-819160-16	UZ-819160-20
UZ-819192-10	UZ-819192-12	UZ-819192-14	UZ-819192-15	UZ-819192-16	UZ-819192-20
UZ-819256-10	UZ-819256-12	UZ-819256-14	UZ-819256-15	UZ-819256-16	UZ-819256-20
UZ-819320-10	UZ-819320-12	UZ-819320-14	-	-	UZ-819320-20

**GTV**



**dugatehna**

## SPOT



ŠIFRA: 92548

03	06	18	20M	10
mosiądz, brąz, natiune, sárgaréž	stal szczotkowana, brushed steel, щрифована сталь, szálcsiszolt acél	złoty szczotkowany, brushed gold, золото щрифоване, szálcsiszolt arany	czarny mat, black matt, чёрный матовый, fekete matt	biały, white, бílый, fehér
GZ-SPOT-1-03	GZ-SPOT-1-06	GZ-SPOT-1-18	GZ-SPOT-1-20M	GZ-SPOT-1-10



## NYXA



ŠIFRA: 92926  
92927  
92928  
92929

20M	18	25
czarny mat, black matt, чорний матовий, fekete matt	złoty szczotkowany, brushed gold, золото шліфоване, szálcsiszolt arany	jasny grafit, bright graphite, світлий графіт könnyű grafit,
UZ-NYXA-128-20M	UZ-NYXA-128-18	UZ-NYXA-128-25
UZ-NYXA-160-20M	UZ-NYXA-160-18	UZ-NYXA-160-25
UZ-NYXA-192-20M	UZ-NYXA-192-18	UZ-NYXA-192-25
UZ-NYXA-320-20M	UZ-NYXA-320-18	UZ-NYXA-320-25



## BAGIO

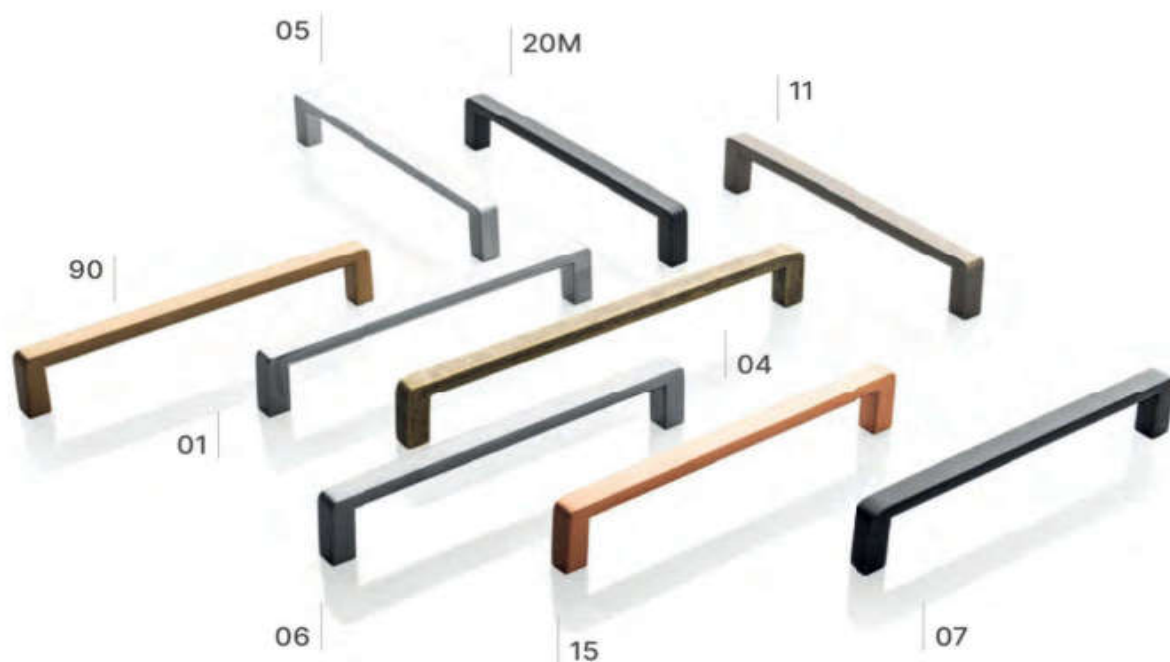

ŠIFRA: 92629  
92630  
92631  
92632  
92633  
92652

01	04	05	06
chrom, chrome, хром, chrom	antyczny mosiądz, antique brass, антична латунь, antik bronz	aluminium, aluminium, алюминий, aluminium	stal szczotkowana, brushed steel, шліфована сталь, szálcsiszolt acél
UZ-BAGIO-128-01	UZ-BAGIO-128-04	UZ-BAGIO-128-05	UZ-BAGIO-128-06
UZ-BAGIO-160-01	UZ-BAGIO-160-04	UZ-BAGIO-160-05	UZ-BAGIO-160-06
UZ-BAGIO-192-01	UZ-BAGIO-192-04	UZ-BAGIO-192-05	UZ-BAGIO-192-06
UZ-BAGIO-320-01	UZ-BAGIO-320-04	UZ-BAGIO-320-05	UZ-BAGIO-320-06

07	11	15
antyczne srebro, antique silver, античне срібло, antik ezüst	tytan szczotkowany brushed titanium шліфований титан csiszolt titán	miedź, copper, мідь, rész
UZ-BAGIO-128-07	UZ-BAGIO-128-11	-
UZ-BAGIO-160-07	UZ-BAGIO-160-11	-
-	UZ-BAGIO-192-11	UZ-BAGIO-192-15
UZ-BAGIO-320-07	UZ-BAGIO-320-11	UZ-BAGIO-320-15

## DUNE



ŠIFRA: 92942

06	16	20M
stal szczotkowana, brushed steel, шліфована сталь, szálcsiszolt acél	złoty mosiądz, gold brass, золота латунь, aranyrész	czarny mat, black matt, чорний матовий, fekete matt
GZ-DUNE-1-06	GZ-DUNE-1-16	GZ-DUNE-1-20M



## PIAZZA



ŠIFRA: 92937

03	06	18	20M
mosiądz, brass, латунь, sárgaréz	stal szczotkowana, brushed steel, шліфована сталь, szálcsiszolt acél	złoty szczotkowany, brushed gold, золото шліфоване, szálcsiszolt arany	czarny mat, black matt, чорний матовий, fekete matt
GZ-PIAZZA-1-03	GZ-PIAZZA-1-06	GZ-PIAZZA-1-18	GZ-PIAZZA-1-20M



## FLAVIO



ŠIFRA: 92740  
92741

01	03	06	16	20M
chrom, chrome, хром, krom	mosiądz, brass, латунь, sárgaréz	stal szczotkowana, brushed steel, шлифована сталь, szálcsiszolt acél	złoty mosiądz, gold brass, золота латунь, aranyréz	czarny mat, black matt, чорний матовий, fekete matt
UZ-FLAVIO-96-01	UZ-FLAVIO-96-03	UZ-FLAVIO-96-06	UZ-FLAVIO-96-16	UZ-FLAVIO-96-20M
UZ-FLAVIO-128-01	UZ-FLAVIO-128-03	UZ-FLAVIO-128-06	UZ-FLAVIO-128-16	UZ-FLAVIO-128-20M
UZ-FLAVIO-160-01	UZ-FLAVIO-160-03	UZ-FLAVIO-160-06	UZ-FLAVIO-160-16	UZ-FLAVIO-160-20M
-	UZ-FLAVIO-192-03	UZ-FLAVIO-192-06	UZ-FLAVIO-192-16	UZ-FLAVIO-192-20M
-	UZ-FLAVIO-320-03	UZ-FLAVIO-320-06	UZ-FLAVIO-320-16	UZ-FLAVIO-320-20M



## NORD



ŠIFRA: 92773



ŠIFRA: 92583  
92584  
92719  
92736

03	18	20M
mosiađz, brass, латунь, sárgaréz	zlóty szczotkowany, brushed gold, золото шніфоване, szácsiszolt arany	czarny mat, black matt, чорний матовий, fekete matt
UZ-NORD-128-03	UZ-NORD-128-18	UZ-NORD-128-20M
UZ-NORD-160-03	UZ-NORD-160-18	UZ-NORD-160-20M
UZ-NORD-192-03	UZ-NORD-192-18	UZ-NORD-192-20M
UZ-NORD-320-03	UZ-NORD-320-18	UZ-NORD-320-20M
GZ-NORD-1-03	GZ-NORD-1-18	GZ-NORD-1-20M



## FABRICIO



18 ŠIFRA: 92547  
92549

03	18	20M
mosiadj, brass, latunь, sárgaréz	zloty szczotkowany, brushed gold, золото шліфоване, szálcsiszolt arany	czarny mat, black matt, чорний матовий, fekete matt
UZ-FABRICIO-128-03	UZ-FABRICIO-128-18	UZ-FABRICIO-128-20M
UZ-FABRICIO-192-03	UZ-FABRICIO-192-18	UZ-FABRICIO-192-20M
UZ-FABRICIO-320-03	UZ-FABRICIO-320-18	UZ-FABRICIO-320-20M



## RAY



ŠIFRA: 92928  
92931  
92932  
92933  
92934



ŠIFRA:92930



18	20M	25
złoty szczotkowany, brushed gold, золото шліфоване, szálcsiszolt arany	czarny mat, black matt, чорний матовий, fekete matt	jasny grafit, bright graphite, світлий графіт, könnyű grafit,
UZ-RAY-128-18	UZ-RAY-128-20M	UZ-RAY-128-25
UZ-RAY-182-18	UZ-RAY-182-20M	UZ-RAY-182-25
UZ-RAY-320-18	UZ-RAY-320-20M	UZ-RAY-320-25
GZ-RAY-1-18	GZ-RAY-1-20M	GZ-RAY-1-25



## OTTO



ŠIFRA: 92925  
92940  
92941

06	90	20M
stal szeczkowana, brushed steel, шрифована сталь, szálcsiszolt acél	szampan, champagne, шампаня, perzsgő	czarny mat, black matt, чорний матовий, fekete matt
UZ-OTTO-128-06	UZ-OTTO-128-90	UZ-OTTO-128-20M
UZ-OTTO-160-06	UZ-OTTO-160-90	UZ-OTTO-160-20M



## LORENA



ŠIFRA: 92935

03	18	20M	21
mosiađz, brass, латунь, sárgaréz	zlóty szczotkowany, brushed gold, золото шрифоване, szálcsiszolt arany	czarny mat, black matt, чорний матовий, fekete matt	szczotkowany antracyt, brushed anthracite, шрифований антрацит, csiszolt antracit,
GZ-LORENA-1-03	GZ-LORENA-1-18	GZ-LORENA-1-20M	GZ-LORENA-1-21



## CAMAIO



SIFRA: 91154

01	02	06	09
chrom, chrome, хром, króm	satyna, satin, сатин, szatén	stal szczotkowana, brushed steel, шліфосана сталь, szálcsiszolt acél	antyczny mosiądz szczotkowany, antique brushed brass, антична шліфосана латунь, antik szálcsiszolt sárgaréz
UZ-CAMAI-96-01	UZ-CAMAI-96-02	UZ-CAMAI-96-06	UZ-CAMAI-96-09
UZ-CAMAI-128-01	UZ-CAMAI-128-02	UZ-CAMAI-128-06	UZ-CAMAI-128-09

10M	12	20M	90
bialy mat, white matt, білий матовий, fehér matt	czarny, chrom; black, chrome; чорний, хром; fekete, króm	czarny mat, black matt, чорний матовий, fekete matt	szampań, champagne, шампань, pezsgő
UZ-CAMAI-96-10M	UZ-CAMAI-96-12	UZ-CAMAI-96-20M	UZ-CAMAI-96-90
UZ-CAMAI-128-10M	UZ-CAMAI-128-12	UZ-CAMAI-128-20M	UZ-CAMAI-128-90

## BERGAMO



ŠIFRA: 91234

01	02	05	06	10	12	20M	90
chrom, chrome, krom, króm	satyna, satin, carré, szatén	aluminium, aluminium, алюминий, aluminium	stal szcztokowana, brushed steel, шлифована сталь, szálcsiszolt acél	bialy, white, білий, fehér	czarny, chrom, black, chrome, чорний, хром, fekete, króm	czarny mat, black matt, чорний матовий, fekete matt	szampa, champagne, шампань, pezsgő
GS-BERGA-1-01	GS-BERGA-1-02	GS-BERGA-1-05	GS-BERGA-1-06	GS-BERGA-1-10	GS-BERGA-1-12	GS-BERGA-1-20M	GS-BERGA-1-90



## UDINE



ŠIFRA: 91257

01	02	05	06	10M	12N	20M
chrom, chrome, хром, króm	satyna, satin, сати́н, szatén	aluminium, aluminium, алюминий, aluminium	stal szczołkowana, brushed steel, шліфована сталь, szálciszolt acél	bijły mat, white mat, білий матовий, fehér matt	czarny chrom, black chrome, чорний хром, fekete króm	czarny mat, black matt, чорний матовий, fekete matt
GZ-UDINE-1-01	GZ-UDINE-1-02	GZ-UDINE-1-05	GZ-UDINE-1-06	GZ-UDINE-1-10M	GZ-UDINE-1-12N	GZ-UDINE-1-20M



## TERNI



SIFRA: 91256

01	02	05	06	09
chrom, chrome, хром, króm	satyna, satin, сатэн, szatén	aluminium, aluminium, алюміній, aluminium	stal szorstkowana, brushed steel, шліфована сталь, szálcsiszolt acél	antyczny mosiądz szorstkowany, antique brushed brass, антична шліфована латунь, antik szálcsiszolt sárgaréz
GZ-TERNI-1-01	-	GZ-TERNI-1-05	GZ-TERNI-1-06	GZ-TERNI-1-09

10	12	15	16	20M
biały, white, білий, fehér	czarny chrom, black chrome, чорний хром, fekete króm	miedź, copper, mідь, rész	złoty mosiądz, gold brass, золота латунь, aranyrész	czarny mat, black matt, чорний матовий, fekete matt
GZ-TERNI-1-10	GZ-TERNI-1-12	GZ-TERNI-1-15	GZ-TERNI-1-16	GZ-TERNI-1-20M

## STRUCTURE



ŠIFRA: 92936/CRNA

ŠIFRA: 92936/CRNA

20M
czarny mat, black matt, чорний матовий, fekete matt
UA-STRUCTURE-128-20M
UA-STRUCTURE-192-20M
GA-STRUCTURE-1-20M



## UA-337



ŠIFRA: 92789

20M



05

ŠIFRA: 91209

05	20M
aluminium, aluminium, алюминий, aluminium	czarny, black, чорний, fekete
UA-00-337096	UA-00-337096-20M
UA-00-337128	UA-00-337128-20M
UA-00-337160	UA-00-337160-20M
UA-00-337192	UA-00-337192-20M
UA-00-337224	UA-00-337224-20M
UA-00-337256	UA-00-337256-20M
UA-00-337320	UA-00-337320-20M

## UA-347



ŠIFRA: 92732

aluminium, aluminium, алюминий, aluminium
UA-00-347128
UA-00-347160
UA-00-347192

## UZ-01



01	02	05
chrom, chrome, хром, króm	satyna, satin, сати́н, szatén	aluminium, aluminium, алюминий, aluminium
UZ-01-096-01	UZ-01-096-02	UZ-01-096-05
UZ-01-128-01	UZ-01-128-02	UZ-01-128-05

ŠIFRA: 91029

## UZ-05



01	02	05
chrom, chrome, хром, króm	satyna, satin, сати́н, szatén	aluminium, aluminium, алюминий, aluminium
UZ-05-096-01	UZ-05-096-02	UZ-05-096-05
UZ-05-128-01	UZ-05-128-02	UZ-05-128-05

ŠIFRA: 91028

## UZ-06



ŠIFRA: 91024  
91025

01	02	05
chrom, chrome, хром, króm	satyna, satin, сати́н, szatén	aluminium, aluminium, алюміній, aluminium
UZ-06-128-01	UZ-06-128-02	UZ-06-128-05

## UZ-07



ŠIFRA: 91030

01	02	05
chrom, chrome, хром, króm	satyna, satin, сати́н, szatén	aluminium, aluminium, алюміній, aluminium
UZ-07-096-01	UZ-07-096-02	UZ-07-096-05

⊕ Informacje techniczne na str. 485  
Technical information on page 485  
Технічна інформація на стор. 485  
Műszaki információk az oldalon 485

## HEXI



ŠIFRA: 92585  
92586  
92624  
92625  
92851  
92885  
92886

	01	05	10M	20M	60	18
	chrom, chrome, хром, króm	aluminium, aluminium, алюминий, aluminium	biały mat, white matt, білий матовий, fehér matt	czarny mat, black matt, чорний матовий, fekete matt	antracyt, anthracite, антрацит, antracit	złoty szczotkowany, brushed gold, золото шліфоване, szálcsiszolt arany
	UA-HEXI-01	UA-HEXI-05	UA-HEXI-10M	UA-HEXI-20M	UA-HEXI-60	UA-HEXI-18
	UA-HEXI96-01	UA-HEXI96-05	UA-HEXI96-10M	UA-HEXI96-20M	UA-HEXI96-60	UA-HEXI96-18
	UA-HEXI-160-01	UA-HEXI-160-05	UA-HEXI-160-10M	UA-HEXI-160-20M	—	—
	UA-HEXI192-01	UA-HEXI192-05	UA-HEXI192-10M	UA-HEXI192-20M	UA-HEXI192-60	UA-HEXI192-18
	UA-HEXI-250-01	UA-HEXI-250-05	UA-HEXI-250-10M	UA-HEXI-250-20M	—	UA-HEXI-250-18
	UA-HEXI-320-01	UA-HEXI-320-05	UA-HEXI-320-10M	UA-HEXI-320-20M	UA-HEXI-320-60	UA-HEXI-320-18
	—	UA-HEXI-3500-05	—	—	—	—



## HEXA



01	05	06	10M	18
chrom, chrome, хром, króm	aluminium, aluminium, алюміній, aluminium	inox, inox, шліфована сталь, inox	biały mat, white matt, білий матовий, fehér matt	złoty szczotkowany, brushed gold, золото шліфоване, szálcsiszolt arany
UA-HEXA-32-01	UA-HEXA-32-05	UA-HEXA-32-06	UA-HEXA-32-10M	UA-HEXA-32-18
UA-HEXA-96-01	UA-HEXA-96-05	UA-HEXA-96-06	UA-HEXA-96-10M	UA-HEXA-96-18
UA-HEXA-160-01	UA-HEXA-160-05	UA-HEXA-160-06	UA-HEXA-160-10M	-
UA-HEXA-192-01	UA-HEXA-192-05	UA-HEXA-160-06	UA-HEXA-192-10M	UA-HEXA-192-18
UA-HEXA-256-01	UA-HEXA-256-05	UA-HEXA-192-06	UA-HEXA-256-10M	-
UA-HEXA-320-01	UA-HEXA-320-05	UA-HEXA-320-06	UA-HEXA-320-10M	-
		UA-HEXA-256-596-06	-	-
		UA-HEXA-352-796-06	-	-

SIFRA: 92258  
92259  
92260  
92261  
92262

20M	22	23
czarny mat, black matt, чорний матовий, fekete matt	jasne złoto szczotkowane, bright brushed gold, світле шліфоване золото, arany	kaszmir, cashmere, кашеміровий, kasmirszínű
UA-HEXA-32-20M	UA-HEXA-32-22	UA-HEXA-32-23
UA-HEXA-64-20M	UA-HEXA-64-22	-
UA-HEXA-96-20M	UA-HEXA-96-22	UA-HEXA-96-23
UA-HEXA-160-20M	UA-HEXA-160-22	UA-HEXA-160-23
UA-HEXA-192-20M	UA-HEXA-192-22	UA-HEXA-192-23
UA-HEXA-256-20M	UA-HEXA-256-22	-
UA-HEXA-320-20M	UA-HEXA-320-22	UA-HEXA-320-23
UA-HEXA-256-596-20M	UA-HEXA-256-596-22	UA-HEXA-256-596-23
UA-HEXA-352-796-20M	UA-HEXA-352-796-22	UA-HEXA-352-796-23

## PICADO

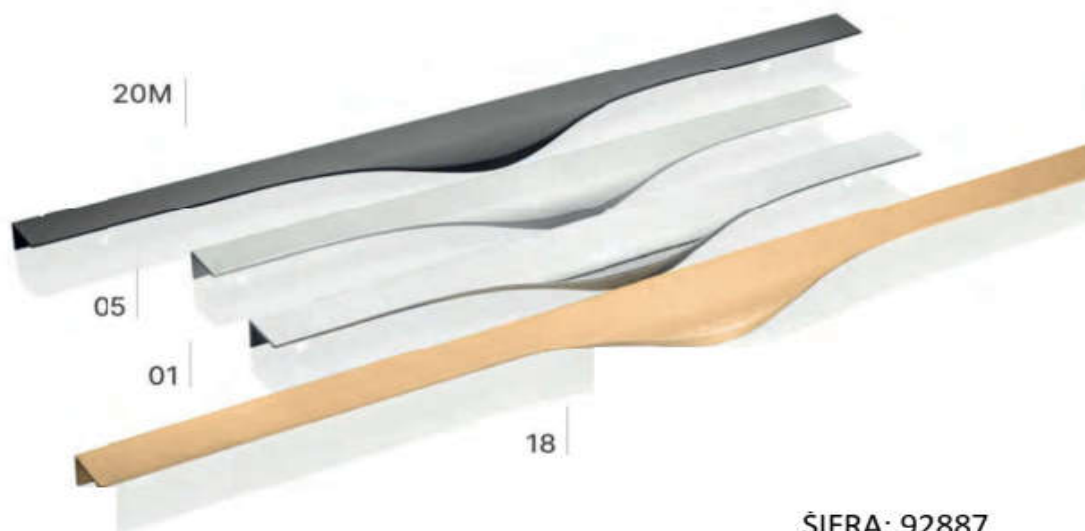

ŠIFRA: 92887

01	05	18	20M
chrom, chrome, хром, krom	aluminium, aluminium, алюміній, aluminium	złoty szczotkowany, brushed gold, золото щіткowane, szálcsiszolt arany	czarny mat, black matt, чорний матовий, fekete matt
UA-PICADO-256-296-01	UA-PICADO-256-296-05	UA-PICADO-256-296-18	UA-PICADO-256-296-20M
UA-PICADO-320-396-01	UA-PICADO-320-396-05	UA-PICADO-320-396-18	UA-PICADO-320-396-20M
UA-PICADO-224-496-01	UA-PICADO-224-496-05	UA-PICADO-224-496-18	UA-PICADO-224-496-20M
UA-PICADO-256-596-01	UA-PICADO-256-596-05	UA-PICADO-256-596-18	UA-PICADO-256-596-20M
UA-PICADO-352-796-01	UA-PICADO-352-796-05	UA-PICADO-352-796-18	UA-PICADO-352-796-20M



## FIORD



ŠIFRA: 92655

03	05	06	16	18	10	20M
mosiądz, brass, latuń, sárgaréz	aluminium, aluminium, aluminium, aluminium	stal szczotkowana, brushed steel, шліфована сталь, szálcsiszolt acél	złoty mosiądz, gold brass, золота латуń, aranyréz	złoty szczotkowany, brushed gold, золото шліфоване, szálcsiszolt arany	biały, white, білий, fehér	czarny mat, black matt, чорний матовий, fekete matt
UZ-FIORD-32-03	UZ-FIORD-32-05	UZ-FIORD-32-06	UZ-FIORD-32-16	UZ-FIORD-32-18	UZ-FIORD-32-10	UZ-FIORD-32-20M

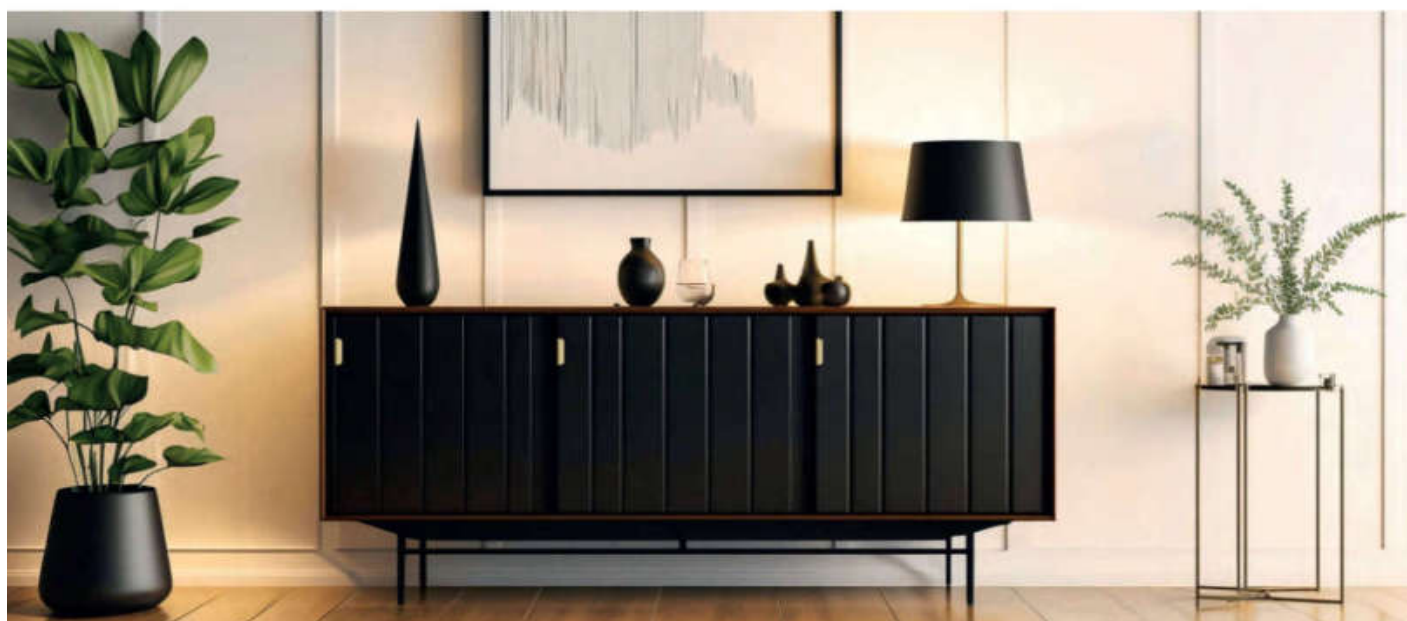

### J4



ŠIFRA: 91135

	04	07
motyw, pattern, мотив, motivum	antyczny miedz, antique brass, антична латунь, antik bronz	antyczne srebro, antique silver, античне срібло, antik ezüst
autumn rose	GP-0728-J4-B	-
spring flower	GP-0728-J4-R	-
blue rose	-	GP-0728-J4-A-07
orient gold	GP-0728-J4-C-04	-

### 728B



ŠIFRA: 91180

motyw, pattern, мотив, motivum	antyczny miedz, antique brass, антична латунь, antik bronz
spring flower	UP-WP0728-BR
country	UP-WP0728-BK
ornament	UP-WP0728-BX
autumn rose	UP-WP0728-BB

## 728P



ŠIFRA: 91196

	04	07
motyw, pattern, мотив, motivum	antyczny mosiądz, antique brass, антична латунь, antik bronz	antyczne srebro, antique silver, античне срібло, antik ezüst
blue rose	UP-WP0728-PA-04*	UP-WP0728-PA-07
orient gold	UP-WP0728-PC-04*	-
ornament	UP-WP0728-PK*	-
autumn rose	UP-WP0728-PB	-
spring flower	UP-WP0728-PR*	-
country	UP-WP0728-PK*	-
milky	UP-WP0728-PD*	-

## MARSALA



ŠIFRA: 91259

07	09	11	15	20M
antyczne srebro, antique silver, античне срібло, antik ezüst	antyczny mosiądz szcziotkowany, antique brushed brass, антична шліфована латунь, antik szálciszolt sárgaréz	tytan szcziotkowany, brushed titanium, матовий титан, csiszolt titán	miedź, copper, мідь, rész	czarny mat, black matt, чорний матовий, fekete matt
UZ-MARSA-64-07	UZ-MARSA-64-09	UZ-MARSA-64-11	UZ-MARSA-64-15	UZ-MARSA-64-20M

## CENTO



ŠIFRA: 91159

04	07	14	20M
antyczny mosiądz, antique brass, антична латунь, antik bronz	antyczne srebro, antique silver, античне срібло, antik ezüst	antyczna miedź, antique copper, антична мідь, antik röz	czarny mat, black matt, чорний матовий, fekete matt
GZ-CENTO-1-04	GZ-CENTO-1-07	GZ-CENTO-1-14	GZ-CENTO-1-20M

## OLBIA



ŠIFRA: 92639

ŠIFRA: 92638

antyczny mosiądz,  
antique brass,  
антична латунь,  
antik bronz

UZ-OLBIA-128-04

GZ-OLBIA-1-04